

DRAFT

THE ENVIRONMENTAL ASSESSMENT SCHEME
Version I. Dated 1 April 2016

DRAFT

SCOTTISH ENVIRONMENT PROTECTION AGENCY

Table of Contents

1. Overview.....	3
2. Background.....	3
3. Emissions to Air – Existing Sites	4
4. Discharges to Water – Existing Sites.....	5
5. Water Abstractions.....	7
6. Water Impoundments.....	9
7. Management of Waste	9
8. Calculating the Environmental Score when there is No Data.....	11
Appendix B1.....	13
Air Factors.....	13
Appendix B2.....	16
Water EQS Values Used for SPRI Sites.....	16
Water EQS Values Used for Non-SPRI Sites	23
Appendix B3: Detailed Guidance on How to Treat Abstractions	25
Appendix B4.....	29
Waste Distribution of EWC.....	29

SCOTTISH ENVIRONMENT PROTECTION AGENCY

1. OVERVIEW

- 1.1 This Document describes SEPA's Environmental Assessment Scheme (EAS). It provides the record of how SEPA calculates the Environmental Assessment Scheme Scores (Environmental Scores).
- 1.2 SEPA will use the Environmental Scores as a means of summarising the environmental significance of activities. We will also use the score as the basis of calculating the Environmental Component of the charges under the Environmental Regulations (Scotland) Charging Scheme 2016.

2. BACKGROUND

- 2.1 This document explains how the EAS calculates an Environmental Score for the following environmental categories:
 - emissions to air (Section 3),
 - discharges to water (Section 4)
 - sewage discharges made by a public utility to water (also Section 4),
 - water abstractions (Section 5),
 - water impoundments (Section 6), and
 - waste management (Section 7).
- 2.2 Where it is not possible to use the methodologies outlined above, then Section 8 describes how the Environmental Score is to be calculated.
- 2.3 The EAS calculates the scale of any emissions, discharges abstractions, impoundments and waste management in an environmentally meaningful way. The Environmental Score is based upon the scale of an activity, which is then modified using a measure of environmental significance.
- 2.4 This allows the comparison of the environmental significance of activities within any given environmental category, but not across them.
- 2.5 Environmental Scores are likely to fall if an operator reduces the scale of their operation, but are likely to increase if the scale of activities increases (and there is no corresponding increase in abatement techniques).
- 2.6 The EAS is only applied to larger scale activities with significant levels of releases to the different environmental categories. This is because such sites
 - have good data available; and
 - are typically responsible for the bulk of the emission, abstraction, impoundment and waste throughput.

SCOTTISH ENVIRONMENT PROTECTION AGENCY

- 2.7 The scale of releases to the different environmental categories from such sites covers many orders of magnitude, with typically a very small number of authorisations that operate at a very large scale. We have used a square-root transformation of the data to “flatten out” the spread of data. This reflects more accurately the amount of effort we use in regulating such emissions.
- 2.8 Activity Types that potentially attract an Environmental Component are listed in the Table in the Schedule to the Charging Scheme. If any activity in an authorisation is so identified, then Environmental Scores are calculated for all relevant environmental categories using all relevant emissions, abstractions, waste throughputs and so forth from all the activities included in the permit.
- 2.9 The EAS uses the data from the past three years’ emissions, discharges or waste throughputs - or the limits in the authorisation - to calculate the Environmental Score for each environmental category.
- 2.10 **Use with SEPA’s charging scheme.** A key use of the Environmental Score is as an input to the Environmental Regulation (Scotland) Charging Scheme 2016. The Environmental Score is used to calculate the Environmental Component of the charging scheme.
- 2.11 A Table of Environmental Scores will be published using this methodology for all authorisations that qualify for an Environmental Score. This will be used for deriving the Environmental Component element of the charging scheme for the period 2016/17 and 2017/18. This table uses the methodology outlined here and discharge data over the period 2012 to 2014, or authorisation conditions in place shortly before the time of publication.
- 2.12 The following sections describe how the scheme derives an Environmental Score for releases to each environmental category – and how the Table of Environmental Scores was derived.

3. EMISSIONS TO AIR – EXISTING SITES

Calculation of Environmental Score to air

- 3.1 In order to calculate the Environmental Score for emissions to air, the following steps are applied:

Step 1 Calculating the emission

- 3.2 We use the emissions to air data for the authorisation as reported to SPRI.
- 3.3 The average mass (kg) released for each pollutant is calculated over a three-year period.
- 3.4 Where the released amount is below the SPRI Reporting Threshold (BRT) then we use a zero emission for that year. This is to simplify the calculation and avoid differentiating between operators who put BRT (and in practice their emissions are actually now almost zero) and those who report zero.

Step 2 Assess the environmental significance

- 3.5 Divide the mass emission for each pollutant calculated in Step 1 by the relevant

SCOTTISH ENVIRONMENT PROTECTION AGENCY

air pollutant threshold given in Appendix B1 to give a score for each individual pollutant. These thresholds are derived from one of the following:

- the Environmental Assessment Level (EAL) - from table B5 of H1¹ annex F 2011;
- using the methodology set out in table B7 of H1 annex F 2011 using the HSE EH40;
- a factor based on the GHG potential - H1 2003;
- a factor using a similar threshold found in the EA's charging scheme (July 2014);
- OSHA occupational exposure limits and then the methodology set out in table B7 of H1 annex F 2011 but using OSHA data rather than HSE EH40; or
- from another assessment.

Step 3 Summing the pollutant scores

- 3.6 Any score for a pollutant with a value below one is discarded as not being significant. The remaining scores are summed to give a total score for the air emissions for the authorisation.
- 3.7 Note for those pollutants identified as VOC's the max of NMVOC/threshold or the sum of Individual VOC/Individual is taken (in order to avoid double counting).

Step 4 Normalising the data

- 3.8 Take the square root of the total score in Step 3 to give the Environmental Score for emissions to air. This "relative" number can be used to compare the scale of overall emissions to air from different authorisations in an environmentally meaningful way.

4. DISCHARGES TO WATER – EXISTING SITES

Calculation of Environmental Score

- 4.1 In order to calculate the Environmental Score for emissions to water, the following steps are applied:

Step 1 Calculating the discharge

For SPRI Reported Pollutant emissions:

- 4.2 Use the discharge to water data reported to SPRI or discharge data calculated from our sampling data for the authorisation.
- 4.3 The average mass (kg) released for each pollutant is calculated over a three-year period. Where the released amount is below the reporting threshold (BRT) for any year it is assumed to be a zero emission.

¹ IPPC H1 - Horizontal Guidance Note : Assessment & Appraisal of BAT

SCOTTISH ENVIRONMENT PROTECTION AGENCY

For Pollutant loads not reported via SPRI:

- 4.4 The discharge concentration is calculated from the three-year average discharge concentration of the samples we take.
- 4.5 The annual discharge flow is derived from one of the following (in order of priority):
- a) Measured flows provided by operators or SEPA and recorded on SEPA systems;
 - b) For public sewage treatment works, by taking the population equivalent (PE) multiplied by 365 days x 414 litres / day (this value is based on an assessment of the relationship of PE for STW where there are measured flow rates);
 - c) Population equivalent data if recorded on the SEPA system.
 - d) Using 75% of the mean daily flow limit;
 - e) Using the dry weather flow; and
 - f) Taking the bottom of the charge band used in the 2015/2016 charging scheme for the discharge. Therefore when the authorised discharge is between the bottom and top bands indicated in the following table then the bottom of the band is used.

Previous Volume Band	Bottom (cubic meters)	Top (cubic meters)
Vp1	0	5
Vp2	5	20
Vp3	20	100
Vp4	100	1,000
Vp5	1,000	10,000
Vp6	10,000	50,000
Vp7	50,000	150,000
Vp8	150,000	Indefinite

- 4.6 The annual mass emission for each pollutant is then calculated by multiplying the concentration by the annual discharge flow. The mass should be converted to kg.

For combined sewer overflows

- 4.7 Insufficient flow or concentration data is available to properly calculate the pollutant mass emission for combined sewer overflows directly. Consequently, the following approach is used:
- The pollutant mass emission from sewage networks is taken as 20% of that produced by the relevant sewage treatment works final effluent load.
 - The pollutant mass emission from the combined sewer overflows at

SCOTTISH ENVIRONMENT PROTECTION AGENCY

sewage treatment works is assumed to be 20% of the sewage treatment final effluent load.

Step 2 Assess the environmental significance

- 4.8 Divide the annual pollutant mass emission derived in Step 1 by the relevant water pollutant threshold to give a pollutant score for each individual pollutant.
- 4.9 The water pollutant thresholds used are given in Appendix B2 (generally they are derived from on the Environmental Quality Standard (EQS)).
- 4.10 Any Score for a pollutant with a value below one is discarded as not being significant

Step 3 summing the pollutant scores

- 4.11 The remaining scores are summed to give a total score for the water emissions for the permit.
- 4.12 Note for those pollutants identified as “drins” (e.g. aldrin, dieldrin) we sum the emissions and then divide by a common threshold, these are identified in Appendix B2.

Step 4. Normalising the data

- 4.13 Take the square root of the total score in Step 3 to give the Environmental Score for discharges to water. This “relative” number can be used to summarise the scale of discharge from different authorisations in an environmentally meaningful way.

5. WATER ABSTRACTIONS

Calculation of Environmental Score for abstractions

- 5.1 In order to calculate the Environmental Score for qualifying abstractions, the following steps are applied.

Step 1. Calculation of abstraction

- 5.2 We use the licensed maximum abstraction volume in cubic metres per day. (Note - in the longer-term we intend to use the actual maximum abstraction volume when the data on abstraction volume has improved.)
- 5.3 This is the sum of all the abstractions covered by the authorisation; however, we only take account of water abstraction once. This is important in situations where water is abstracted many times during its passage down a cascade (e.g. a major hydropower scheme).
- 5.4 Take the square root of the maximum daily abstraction volume.

Step 2 Assess the environmental significance

- 5.5 We use the following factors (listed in Table B1) to define the environmental significance of the abstraction:
 - length of river affected, and
 - time of year that water is abstracted.
- 5.6 We multiply the abstraction volume from Step 1 by the relevant factors for

SCOTTISH ENVIRONMENT PROTECTION AGENCY

length of river affected (Length Factor) and Seasonality Factor listed in Table B1 below to give the Environmental Score for water abstraction.

Table B1
Length of River and Seasonality Factors

Code	Length of river affected	Length Factor	Seasonality Code	Seasonality	Seasonality Factor
Le1	Returned < 500m from Abstraction. This is applied to all hydro schemes where the charge came under the less than 5MW threshold.	0.1	Se1	Winter (Nov – March)	0.21
Le2	Returned 500m to <1km from Abstraction	0.9	Se2	Summer only (April – Oct.)	0.79
Le3	Returned 1km to 5km from Abstraction	1.3	Se3	All year	1
Le4	Returned > 5km from Abstraction	1.9			
Le5	No return of water. No return of water = (this is applied when the less than 5% of the abstraction is returned OR it is returned more than 5km from the abstraction point and between 10% and 95% of the abstraction is returned.)”.	3.5			

5.7 Length Affected Band will be determined by the distance, measured along the Bank, between an abstraction point and the point at which the water is returned to the water environment. For the avoidance of doubt, the Length Affected Band will be Le1 for

- coastal and estuarine abstractions, and
- abstractions from a loch that are returned to the same loch.

5.8 For abstractions from groundwater the Length Affected Band will be determined by the straight line distance between the borehole / point of issue and the point of return to the water environment.

5.9 Further detailed guidance on aspects of how to treat abstraction is given in Appendix B3.

SCOTTISH ENVIRONMENT PROTECTION AGENCY

6. WATER IMPOUNDMENTS

Calculation of Environmental Score

- 6.1 The Environmental Score for water impoundments is calculated by taking the square root of the maximum impounded volume (in cubic meters) listed in the permit.
- 6.2 Where the maximum impounded volume is less than 25,000m³, the Environmental Score is taken as zero.

7. MANAGEMENT OF WASTE

Calculation of Environmental Score

- 7.1 In order to calculate the Environmental Score for waste management, the following steps are applied:

Step 1 Calculating the weight of material managed

- 7.2 The site return data is used to calculate the average annual tonnage for each EWC code over the relevant three years. The EAS uses the European Waste Category (EWC) Table B returns, which are made by all permitted waste management sites. EWC Table B records the type and quantity of waste entering a site.

Step 2 Assess the environmental significance

- 7.3 There are two factors used to assess the environmental significance.
- i) Risk posed by the material handled. Each EWC code is categorised as high, medium or low risk using Appendix B4 Table B4-1. Each risk category has been allocated factor (Table B2)
- ii) How the material is handled. This takes account of whether material is recovered/recycled, energy is recovered, or everything disposed (also shown on Table B2).

Table B2
Material hazard and waste management activity factors

Material hazard band	Factor	Waste management activity	Factor
Low	1	Material recovery/recycling	1
Medium	4	Energy recovery only	3
High	5	Disposal (landfill)	5

SCOTTISH ENVIRONMENT PROTECTION AGENCY

7.3.1 For waste going to each type of waste management activity (material recovery/recycling, energy recovery only, disposal (landfill)) they are then split by the material hazard band that has been given for each waste EWC code (Appendix B4).

7.3.2 The tonnages of waste with the same material hazard band and treated in the same class of waste management activity are divided by the corresponding thresholds given in Table B3 (e.g. waste classed as “High Risk” and is subject to waste management activity of “recovery” would have a threshold of 12,000).

To illustrate this an example is given below.

For a site which undertakes recovery of the material with an average throughput of 680 tonnes/yr classed as high hazard and 63320 tonnes/yr of medium. You would do the following calculation:

EWC Code	Material hazard band	Description of Waste	Tonnes / yr	Threshold	Score
13 02 08	High	Waste Oil	680	12000 (recovery, high risk)	0.06
17 04 07	Medium	mixed metals	63320	15000 (recovery, medium risk)	4.22
Total					4.28

The waste thresholds are taken from the following table (which is table B3 but with emphasised text for the example).

Material hazard band	Waste management activity			
	Material recovery/recycling		Energy recovery only	Disposal (landfill)
	All onsite treatment	Everything else not covered by the other columns	Waste which is incinerated	Waste which is landfilled
Low risk	60,000	60,000	20,000	12,000
Medium risk	15,000	15,000	5000	3000
High risk	12,000	12,000	4000	2400

Step 3 Summing the waste throughput score

You sum the scores for the site waste management activities to give a total waste throughput score. Any resulting total score below 1 is then discarded.

7.4 Step 4 Normalising the data

7.4.1 Take the square root of the total score in Step 3 to give the Environmental Score for waste management.

SCOTTISH ENVIRONMENT PROTECTION AGENCY

Table B3

Waste throughput thresholds by treatment / disposal mechanism

Material hazard band	Waste management activity			
	Material recovery/recycling		Energy recovery only	Disposal (landfill)
	All onsite treatment	Everything else not covered by the other columns	Waste which is incinerated	Waste which is landfilled
Low risk	60,000	60,000	20,000	12,000
Medium risk	15,000	15,000	5000	3000
High risk	12,000	12,000	4000	2400

8. CALCULATING THE ENVIRONMENTAL SCORE WHEN THERE IS NO DATA

- 8.1 There will be a number of circumstances under which there is no data available to calculate an Environmental Score. This could be due to various potential issues:
1. The permit relates to a new site/activity and so there is no historic information on actual emissions or waste throughput.
 2. The permit relates to a substantial change at an existing site.
 3. It is a site returning to operation after mothballing or following a period of being fallow (fish farms).
- 8.2 Under such circumstances where data is not available SEPA will use the following hierarchy to calculate the Environmental Score:
- 8.3 For abstraction and impoundments, since these are based on the licensed values, the data is available and an environmental score can be directly calculated from this (as in Sections 5 and 6).
- 8.4 For sites that have modelled emissions calculated for their SPRI returns the modeled pollutant values will be used. Examples of the types of activities where this approach is taken include intensive agriculture sites, marine cage fish farms, landfills and sewage treatment works >15,000 pe.
- 8.5 If 8.4 and 8.5 do not apply, the following rules apply instead.
- 8.6 For air / water emissions, the mass of pollutant emissions to air or water will be estimated as 50% of the limit in the permit or the predicted mass based on the application maximum estimated releases (this is relevant to, for example, to a PPC site where operations may be on a periodic basis rather than continuous). The pollutant load and the Environmental Score are then calculated as described above.
- 8.7 The EWC code waste throughput will be 50% of the maximum estimated input of waste, which the site will handle on a daily basis, scaled up on a pro-rata basis of operating days.
- 8.8 There may be some applications which clearly demonstrate lower emissions / waste throughputs and we will take these into account.

SCOTTISH ENVIRONMENT PROTECTION AGENCY

- 8.9 The Environmental Score is calculated using the values outlined above using the methods described in section 4 – 7. The following provide some examples. SEPA will periodically review the Environmental score based on actual values reported, sampled or assessed and revise the score accordingly.

DRAFT

AIR FACTORS

Table B1-1

Air Factors

Material	Air Pollutant Threshold	VOC (for comparison with NMVOC)	Comment
Acetaldehyde	370		IPPC H1 - Horizontal Guidance Note : Assessment & Appraisal of BAT -Table B5
Ammonia	180		
Antimony	5		
Arsenic	0.2		
Benzene	16.25	Yes	
Benzo(a) pyrene	0.5		Occupational Safety & Health Administration – Permissible Exposure Limits
Butadiene	44	Yes	HSE EH40 and methodology in Table B7
Cadmium	0.005		IPPC H1 - Horizontal Guidance Note : Assessment & Appraisal of BAT -Table B5
Carbon disulphide	64		
Chloroform	99		
Chromium	5		
Dioxins and furans - as ITEQ	0.00001		Derived other
<i>Ethylbenzene</i>	4410	Yes	IPPC H1 - Horizontal Guidance Note : Assessment & Appraisal of BAT -Table B5
Ethylene	500	Yes	Environment Agency's Opra Scheme
Ethylene dichloride	42		HSE EH40 and methodology in Table B7
Ethylene oxide	18.4		IPPC H1 - Horizontal Guidance

SCOTTISH ENVIRONMENT PROTECTION AGENCY

Material	Air Pollutant Threshold	VOC (for comparison with NMVOC)	Comment
Formaldehyde	5	Yes	Note : Assessment & Appraisal of BAT -Table B5
Hexane	720	Yes	
Hydrogen Cyanide	33.3		HSE EH40 and methodology in Table B7
Lead	0.5		IPPC H1 - Horizontal Guidance Note : Assessment & Appraisal of BAT -Table B5
<i>Manganese</i>	5		
<i>Methanol</i>	2660	Yes	
Mercury	0.25		
Methyl chloride	700		
Methyl chloroform	11100	Yes	
Methylene chloride	700		
Nickel	10		
PAHs	1		EA's charging scheme
Phenols - total as C	200		IPPC H1 - Horizontal Guidance Note : Assessment & Appraisal of BAT -Table B5
Polychlorinated biphenyls (PCBs) - as WHO TEQ	0.2		
Selenium	1		
Styrene	800		
Tetrachloroethane	3450		Use Trichlorethylene
<i>Toluene</i>	1910	Yes	IPPC H1 - Horizontal Guidance Note : Assessment & Appraisal of BAT -Table B5
<i>Trichlorobenzene (all isomers)</i>	75		
Trichloroethylene	3450		
Vinyl chloride	159		
Xylene - all isomers	4410	Yes	
<i>Zinc</i>	100		

SCOTTISH ENVIRONMENT PROTECTION AGENCY

Greenhouse Gas Factors

**Table B 1-2
Greenhouse Gas Factors**

Material	Air Pollutant Threshold
<i>Chlorofluorocarbons (CFCs)</i>	10
Sulphur hexafluoride	10
Hydrochlorofluorocarbons (HCFCs)	100
Hydrofluorocarbons (HFCs)	100
Perfluorocarbons (PFCs)	100
Methane	1000
Non-methane volatile organic compounds (NMVOCs)	5000

Large Mass Emissions from Combustion Processes

**Table B1-3:
Large Mass Emissions from Combustion Processes**

Material	Air Pollutant Threshold
Fluorine and total inorganic fluorine compounds - as HF	10
Chlorine and total inorganic chlorine compounds - as HCl	1000
Hydrogen chloride	1000
Nitrogen oxides, NO and NO ₂ as NO ₂	10000
Nitrous Oxide	10000
Sulphur oxides, SO ₂ and SO ₃ as SO ₂	10000
Carbon monoxide	1000000
Particulate matter - PM ₁₀ and smaller	100

APPENDIX B2

WATER EQS VALUES USED FOR SPRI SITES

The following threshold values are based on environmental quality standards or an estimate based on scientific advice. The threshold values are given the units of kilograms purely to ensure that when using SPRI and sampling data this is converted into similar units.

**Table B2-1:
Water Pollutant Thresholds for SPRI Pollutants**

SPRI POLLUTANT_NAME	SPRI POLLUTANT_ID	Receiving Water	Water Pollutant Threshold
2,4-Dichlorophenoxyacetic acid (2,4-D) - ester and non-ester	170	Inland waters	0.3
2,4-Dichlorophenoxyacetic acid (2,4-D) - ester and non-ester	170	Transitional waters	0.3
2,4-Dichlorophenoxyacetic acid (2,4-D) - ester and non-ester	170	Coastal waters	0.3
Aldrin	15	Inland waters	0.01
Aldrin	15	Transitional waters	0.005
Aldrin	15	Coastal waters	0.005
Arsenic	99	Inland waters	65
Arsenic	99	Transitional waters	33
Arsenic	99	Coastal waters	33
Atrazin	19	Inland waters	0.6
Atrazin	19	Transitional waters	0.6
Atrazin	19	Coastal waters	0.6
Benzene	21	Inland waters	10
Benzene	21	Transitional waters	8

SCOTTISH ENVIRONMENT PROTECTION AGENCY

SPRI POLLUTANT_NAME	SPRI POLLUTANT_ID	Receiving Water	Water Pollutant Threshold
Benzene	21	Coastal waters	8
Cadmium	102	Inland waters	0.3
Cadmium	102	Transitional waters	0.4
Cadmium	102	Coastal waters	0.4
Carbon Tetrachloride	29	Inland waters	12
Carbon Tetrachloride	29	Transitional waters	12
Carbon Tetrachloride	29	Coastal waters	12
Chlorfenvinphos	277	Inland waters	0.1
Chlorfenvinphos	277	Transitional waters	0.1
Chlorfenvinphos	277	Coastal waters	0.1
Chloroform	30	Inland waters	2.5
Chloroform	30	Transitional waters	2.5
Chloroform	30	Coastal waters	2.5
Chromium	103	Inland waters	6.8
Chromium	103	Transitional waters	1.2
Chromium	103	Coastal waters	1.2
Copper	104	Inland waters	43
Copper	104	Transitional waters	215
Copper	104	Coastal waters	215
Diazinon	137	Inland waters	0.01
Diazinon	137	Transitional waters	0.01
Diazinon	137	Coastal waters	0.01

SCOTTISH ENVIRONMENT PROTECTION AGENCY

SPRI POLLUTANT_NAME	SPRI POLLUTANT_ID	Receiving Water	Water Pollutant Threshold
Dichlorodiphenyltrichloroethane - all isomers	37	Inland waters	0.025
Dichlorodiphenyltrichloroethane - all isomers	37	Transitional waters	0.025
Dichlorodiphenyltrichloroethane - all isomers	37	Coastal waters	0.025
Dieldrin	39	Inland waters	0.01
Dieldrin	39	Transitional waters	0.005
Dieldrin	39	Coastal waters	0.005
Dimethoate	138	Inland waters	0.48
Dimethoate	138	Transitional waters	0.48
Dimethoate	138	Coastal waters	0.48
Endosulfan	46	Inland waters	0.005
Endosulfan	46	Transitional waters	0.0005
Endosulfan	46	Coastal waters	0.0005
Endrin	47	Inland waters	0.01
Endrin	47	Transitional waters	0.005
Endrin	47	Coastal waters	0.005
Ethylene dichloride	55	Inland waters	10
Ethylene dichloride	55	Transitional waters	10
Ethylene dichloride	55	Coastal waters	10
Hexachlorobenzene	59	Inland waters	0.01
Hexachlorobenzene	59	Transitional waters	0.01
Hexachlorobenzene	59	Coastal waters	0.01

SCOTTISH ENVIRONMENT PROTECTION AGENCY

SPRI POLLUTANT_NAME	SPRI POLLUTANT_ID	Receiving Water	Water Pollutant Threshold
Hexachlorobutadiene	144	Inland waters	0.1
Hexachlorobutadiene	144	Transitional waters	0.1
Hexachlorobutadiene	144	Coastal waters	0.1
Hexachlorocyclohexane - all isomers	60	Inland waters	0.02
Hexachlorocyclohexane - all isomers	60	Transitional waters	0.002
Hexachlorocyclohexane - all isomers	60	Coastal waters	0.002
Isodrin	283	Inland waters	0.01
Isodrin	283	Transitional waters	0.005
Isodrin	283	Coastal waters	0.005
Lead	105	Inland waters	28.8
Lead	105	Transitional waters	28.8
Lead	105	Coastal waters	28.8
Linuron	146	Inland waters	0.5
Linuron	146	Transitional waters	0.5
Linuron	146	Coastal waters	0.5
Mecoprop	149	Inland waters	18
Mecoprop	149	Transitional waters	18
Mecoprop	149	Coastal waters	18
Mercury	107	Inland waters	0.5
Mercury	107	Transitional waters	0.5
Mercury	107	Coastal waters	0.5
Naphthalene	152	Inland waters	2.4

SCOTTISH ENVIRONMENT PROTECTION AGENCY

SPRI POLLUTANT_NAME	SPRI POLLUTANT_ID	Receiving Water	Water Pollutant Threshold
Naphthalene	152	Transitional waters	1.2
Naphthalene	152	Coastal waters	1.2
Nickel	108	Inland waters	40
Nickel	108	Transitional waters	40
Nickel	108	Coastal waters	40
Nitrogen - total as N	153	Inland waters	559
Nitrogen - total as N	153	Transitional waters	559
Nitrogen - total as N	153	Coastal waters	335
Nonylphenoethoxylates	154	Inland waters	
Nonylphenoethoxylates	154	Transitional waters	
Nonylphenoethoxylates	154	Coastal waters	
Nonylphenols	155	Inland waters	0.3
Nonylphenols	155	Transitional waters	0.3
Nonylphenols	155	Coastal waters	0.3
Octylphenols	157	Inland waters	0.1
Octylphenols	157	Transitional waters	0.01
Octylphenols	157	Coastal waters	0.01
Pentachlorophenol	78	Inland waters	0.4
Pentachlorophenol	78	Transitional waters	0.4
Pentachlorophenol	78	Coastal waters	0.4
Permethrin	159	Inland waters	0.001
Permethrin	159	Transitional	0.0002

SCOTTISH ENVIRONMENT PROTECTION AGENCY

SPRI POLLUTANT_NAME	SPRI POLLUTANT_ID	Receiving Water	Water Pollutant Threshold
		waters	
Permethrin	159	Coastal waters	0.0002
Phosphorus - total as P	161	Inland waters	126
Phosphorus - total as P	161	Transitional waters	1260
Phosphorus - total as P	161	Coastal waters	
Polychlorinated biphenyls	265	Inland waters	0.01
Polychlorinated biphenyls	265	Transitional waters	
Polychlorinated biphenyls	265	Coastal waters	
Simazine	85	Inland waters	1
Simazine	85	Transitional waters	1
Simazine	85	Coastal waters	1
Tetrachloroethylene	88	Inland waters	10
Tetrachloroethylene	88	Transitional waters	10
Tetrachloroethylene	88	Coastal waters	10
Toluene	89	Inland waters	74
Toluene	89	Transitional waters	74
Toluene	89	Coastal waters	74
Tributyltin compounds	167	Inland waters	0.0002
Tributyltin compounds	167	Transitional waters	0.0002
Tributyltin compounds	167	Coastal waters	0.0002
Trichlorobenzene - all isomers	91	Inland waters	0.4
Trichlorobenzene - all isomers	91	Transitional waters	0.4

SCOTTISH ENVIRONMENT PROTECTION AGENCY

SPRI POLLUTANT_NAME	SPRI POLLUTANT_ID	Receiving Water	Water Pollutant Threshold
Trichlorobenzene - all isomers	91	Coastal waters	0.4
Trichloroethylene	92	Inland waters	10
Trichloroethylene	92	Transitional waters	10
Trichloroethylene	92	Coastal waters	10
Trifluralin	168	Inland waters	0.03
Trifluralin	168	Transitional waters	0.03
Trifluralin	168	Coastal waters	0.03
Triphenyltin compounds	290	Inland waters	0.02
Triphenyltin compounds	290	Transitional waters	0.008
Triphenyltin compounds	290	Coastal waters	0.008
Xylene - all isomers	97	Inland waters	30
Xylene - all isomers	97	Transitional waters	30
Xylene - all isomers	97	Coastal waters	30
Zinc	111	Inland waters	58.86
Zinc	111	Transitional waters	42.66
Zinc	111	Coastal waters	42.66

SCOTTISH ENVIRONMENT PROTECTION AGENCY

WATER EQS VALUES USED FOR NON-SPRI SITES

Table B2-2:

Water Pollutant Thresholds for Non SPRI Sites

POLLUTANTS NOT REPORTED VIA SPRI	SPRI POLLUTANT _ID	Receiving Water	Water Pollutant Threshold (kg)
Biochemical Oxygen Demand - total	220200	Coastal waters	30000
Biochemical Oxygen Demand - total	220200	Transitional waters	30000
Biochemical Oxygen Demand - total	220200	Inland waters	3000
Ammoniacal Nitrogen (as N)	250200	Coastal waters	300
Ammoniacal Nitrogen (as N)	250200	Transitional waters	300
Ammoniacal Nitrogen (as N)	250200	Inland waters	300
Nitrate (as N)	250250	Coastal waters	168
Nitrate (as N)	250250	Transitional waters	280
Nitrate (as N)	250250	Inland waters	280
Total Nitrogen (as N)	250260	Coastal waters	335
Total Nitrogen (as N)	250260	Transitional waters	559
Total Nitrogen (as N)	250260	Inland waters	559
Orthophosphate (as P)	250300	Coastal waters	0
Orthophosphate (as P)	250300	Transitional waters	420
Orthophosphate (as P)	250300	Inland waters	42
Phosphorus (as P)	250320	Coastal waters	0
Phosphorus (as P)	250320	Transitional waters	1260
Phosphorus (as P)	250320	Inland waters	126

SCOTTISH ENVIRONMENT PROTECTION AGENCY

POLLUTANTS NOT REPORTED VIA SPRI	SPRI POLLUTANT _ID	Receiving Water	Water Pollutant Threshold (kg)
Manganese	300180	Coastal waters	492
Manganese	300180	Transitional waters	492
Manganese	300180	Inland waters	492
Copper	300210	Coastal waters	215
Copper	300210	Transitional waters	215
Copper	300210	Inland waters	43
Lead	300230	Coastal waters	28.8
Lead	300230	Transitional waters	28.8
Lead	300230	Inland waters	28.8
Zinc	300240	Coastal waters	42.66
Zinc	300240	Transitional waters	42.66
Zinc	300240	Inland waters	58.86
Total organic carbon or COD/3	166	Coastal waters	150000
Total organic carbon or COD/3	166	Transitional waters	150000
Total organic carbon or COD/3	166	Inland waters	15000

APPENDIX B3: DETAILED GUIDANCE ON HOW TO TREAT ABSTRACTIONS

In calculating abstraction charges, operators will only be charged once for the abstraction of water. The examples below explain how the volume abstracted factor is applied in different scenarios.

In some cases it is the initial abstraction volume that is subject to charging (Example 2, farm ponds). However for river transfer schemes this may not be the case as the second abstraction can take advantage of the increased catchment upstream (Example 6) in which case the charge is based on the second abstraction volume.

The following examples demonstrate that in a complex scheme, the net volume utilised by the operator may *increase* with subsequent re-abstractions (Example 1, Hydro Power Cascades), or it may *decrease*:

- due to spill, and compensation releases, the net volume may be significantly *less* than the sum of individual abstractions (Example 4, public water supply)
- similarly, lade abstractions take only a proportion of the water diverted into the lade (Example 3)

Example 1: Hydropower system with multiple sites, single licence

Abstractions:

- A1,A2,A3,A4,A5
- A1,A2,A3,A4 all contribute to A5
- multiple re-abstractions
- A1 and A2 are re-abstracted at A3, A5
- A3 and A4 are re-abstracted at A5
- volume abstracted increases downstream
- all water passing HEP3 is used by operator

Charge:

- Only charge once for each MI abstracted
- Volume abstracted increases downstream
- All water passing HEP3 is used by operator

→ Charge volume band is based on abstraction at A5 ONLY

KEY

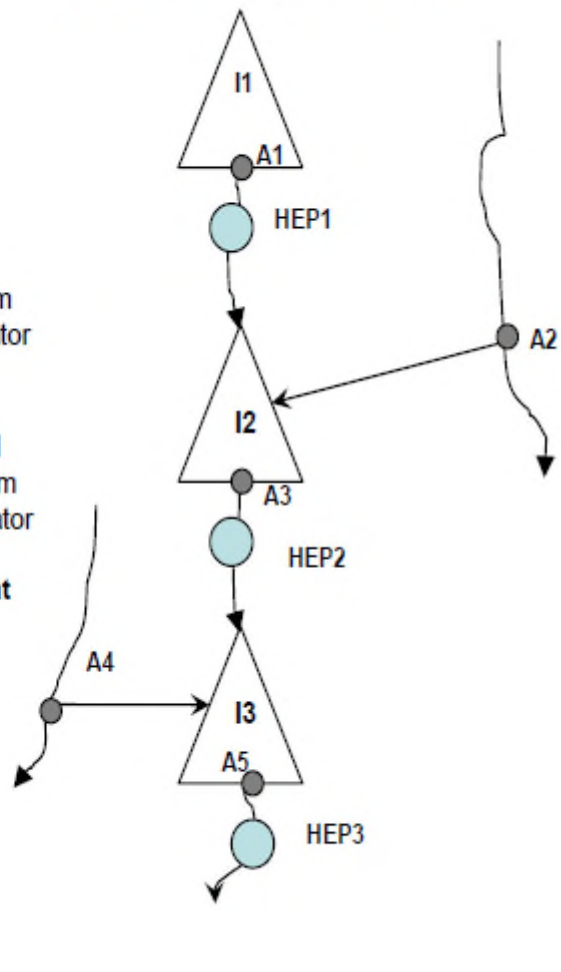
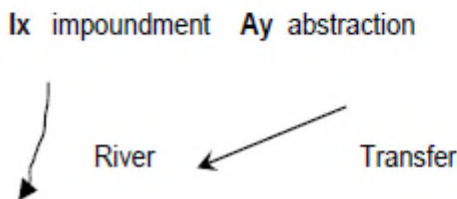

Example 2: Farm ponds / offline storage

Abstraction:

A1 to fill off-line storage
T2 from storage at time of irrigation

Charge:

Charge once only for each MI
Water all used
T2 NOT a regulated abstraction
Assess volume band at A1

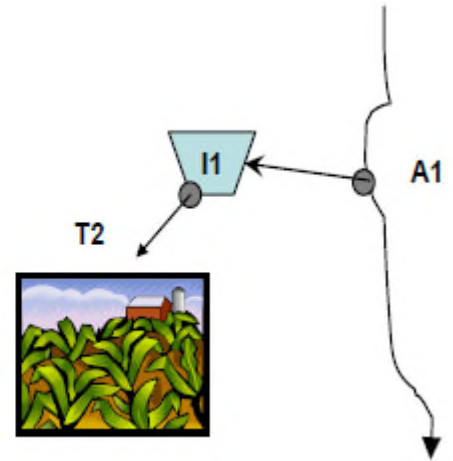

Example 3: Lades

Abstraction:

A1 from river into lade
A2 from lade for process use
 $A2 < A1$

Charge:

Only a proportion of A1 used
Assess volume band at A2

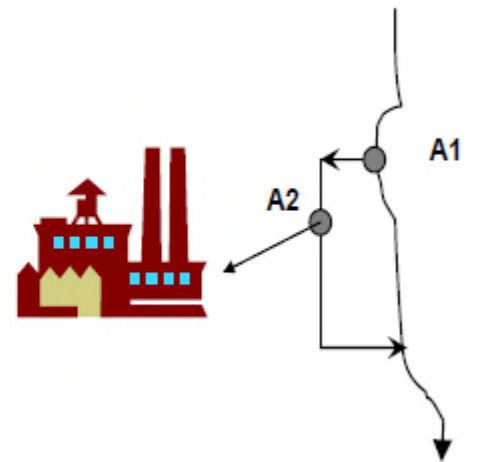

Example 4: Public water supply multi-site System, single licence

Measured at M1, M2

Abstraction:

A1,A2,A3,A4,A5
 water abstracted at A1,A2,A5 may spill
 $M2 < A1+A2$
 $A3 < A1+A2+A5$
 much of A3 is re-abstracted
 $M1 = A4+A3$

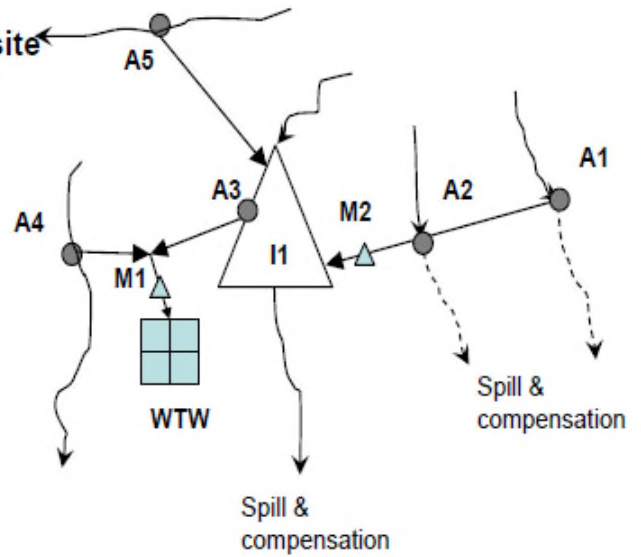

KEY - as examples above plus

△ Mx Monitoring point

Charging:

Only charge once for each MI
 Much of abstracted water can be compensation, spill
 Only $M1 = A3 + A4$ is used by operator.
Assess volume band as M1

Example 5: Public water supply 2 reservoirs, single licence

Abstraction:

A1, A2
 Total = $A1+A2$

Charging:

Only charge once for each MI
Assess volume band as $(A1 + A2)$

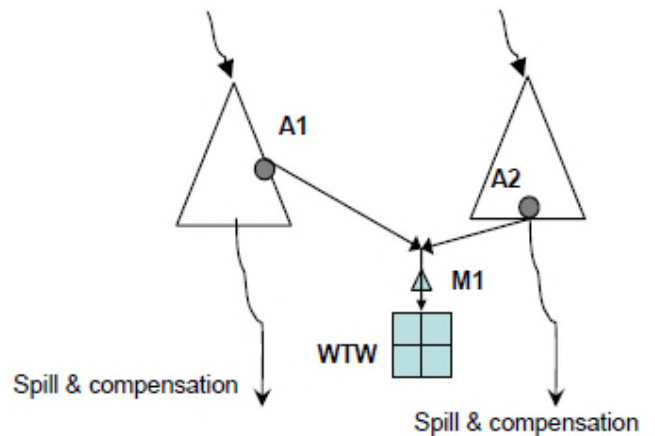

Example 6: Public water supply river transfer

Abstraction:

A2 may =A1, is unlikely to be less but may well be significantly greater

Charging:

Volume band based on A2

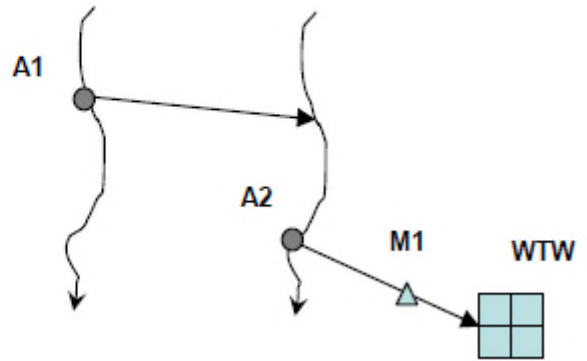

DRAFT

WASTE DISTRIBUTION OF EWC

Each EWC is assigned whether it is High, Medium or Low in hazardous nature. This roughly equates to High - Hazardous, Medium - Non-Hazardous and Low - inert.

Table B4-1

EWC Description Versus Charging Classification

EWC description	Waste Classification	Charging Classification
01 01 01 wastes from mineral metalliferous excavation	Non-Hazardous	Medium
01 01 02 wastes from mineral non-metalliferous excavation	Non-Hazardous	Medium
01 03 04* acid-tailings from processing of sulphide ore	Hazardous	High
01 03 05* other tailings containing dangerous substances	Hazardous	High
01 03 06 tailings other than those mentioned in 01 03 04 and 0 1 03 05	Non-Hazardous	Medium
01 03 07* other wastes containing dangerous substances from physical and chemical processing of metalliferous minerals	Hazardous	High
01 03 08 dusty and powdery wastes other than those mentioned in 01 03 07	Non-Hazardous	Medium
01 03 09 red mud from alumina production other than the wastes mentioned in 01 03 07	Non-Hazardous	Medium
01 03 99 wastes not otherwise specified	Non-Hazardous	Medium
01 04 07* wastes containing dangerous substances from physical and chemical processing of non-metalliferous minerals	Hazardous	High
01 04 08 waste gravel and crushed rocks other than those mentioned in 01 04 07	Non-Hazardous	Medium
01 04 09 waste sand and clays	Non-Hazardous	Medium
01 04 10 dusty and powdery wastes other than those mentioned in 01 04 07	Non-Hazardous	Medium

SCOTTISH ENVIRONMENT PROTECTION AGENCY

EWC description	Waste Classification	Charging Classification
01 04 11 wastes from potash and rock salt processing other than those mentioned in 01 04 07	Non-Hazardous	Medium
01 04 12 tailings and other wastes from washing and cleaning of minerals other than those mentioned in 01 04 07 and 01 04 11	Non-Hazardous	Medium
01 04 13 wastes from stone cutting and sawing other than those mentioned in 01 04 07	Non-Hazardous	Medium
01 04 99 wastes not otherwise specified	Non-Hazardous	Medium
01 05 04 freshwater drilling muds and wastes	Non-Hazardous	Medium
01 05 05* oil-containing drilling muds and wastes	Hazardous	High
01 05 06* drilling muds and other drilling wastes containing dangerous substances	Hazardous	High
01 05 07 barite-containing drilling muds and wastes other than those mentioned in 01 05 05 and 01 05 06	Non-Hazardous	Medium
01 05 08 chloride-containing drilling muds and wastes other than those mentioned in 01 05 05 and 01 05 06	Non-Hazardous	Medium
01 05 99 wastes not otherwise specified	Non-Hazardous	Medium
02 01 01 sludges from washing and cleaning	Non-Hazardous	Medium
02 01 02 animal tissue waste	Non-Hazardous	Medium
02 01 03 plant tissue waste	Non-Hazardous	Medium
02 01 04 waste plastics (except packaging)	Non-Hazardous	Medium
02 01 06 animal faeces, urine and manure (including spoiled straw), effluent, collected separately and treated off-site	Non-Hazardous	Medium

SCOTTISH ENVIRONMENT PROTECTION AGENCY

EWC description	Waste Classification	Charging Classification
02 01 07 wastes from forestry	Non-Hazardous	Medium
02 01 08* agrochemical waste containing dangerous substances	Hazardous	High
02 01 09 agrochemical wastes other than those mentioned in 02 01 08	Non-Hazardous	Medium
02 01 10 waste metal	Non-Hazardous	Medium
02 01 99 wastes not otherwise specified	Non-Hazardous	Medium
02 02 01 sludges from washing and cleaning	Non-Hazardous	Medium
02 02 02 animal tissue waste	Non-Hazardous	Medium
02 02 03 materials unsuitable for consumption or processing	Non-Hazardous	Medium
02 02 04 sludges from on-site effluent treatment	Non-Hazardous	Medium
02 02 99 wastes not otherwise specified	Non-Hazardous	Medium
02 03 01 sludges from washing, cleaning, peeling, centrifuging and separation	Non-Hazardous	Medium
02 03 02 wastes from preserving agents	Non-Hazardous	Medium
02 03 03 wastes from solvent extraction	Non-Hazardous	Medium
02 03 04 materials unsuitable for consumption or processing	Non-Hazardous	Medium
02 03 05 sludges from on-site effluent treatment	Non-Hazardous	Medium
02 03 99 wastes not otherwise specified	Non-Hazardous	Medium
02 04 01 soil from cleaning and washing beet	Non-Hazardous	Medium
02 04 02 off-specification calcium carbonate	Non-Hazardous	Medium

SCOTTISH ENVIRONMENT PROTECTION AGENCY

EWC description	Waste Classification	Charging Classification
02 04 03 sludges from on-site effluent treatment	Non-Hazardous	Medium
02 04 99 wastes not otherwise specified	Non-Hazardous	Medium
02 05 01 materials unsuitable for consumption or processing	Non-Hazardous	Medium
02 05 02 sludges from on-site effluent treatment	Non-Hazardous	Medium
02 05 99 wastes not otherwise specified	Non-Hazardous	Medium
02 06 01 materials unsuitable for consumption or processing	Non-Hazardous	Medium
02 06 02 wastes from preserving agents	Non-Hazardous	Medium
02 06 03 sludges from on-site effluent treatment	Non-Hazardous	Medium
02 06 99 wastes not otherwise specified	Non-Hazardous	Medium
02 07 01 wastes from washing, cleaning and mechanical reduction of raw materials	Non-Hazardous	Medium
02 07 02 wastes from spirits distillation	Non-Hazardous	Medium
02 07 03 wastes from chemical treatment	Non-Hazardous	Medium
02 07 04 materials unsuitable for consumption or processing	Non-Hazardous	Medium
02 07 05 sludges from on-site effluent treatment	Non-Hazardous	Medium
02 07 99 wastes not otherwise specified	Non-Hazardous	Medium
03 01 01 waste bark and cork	Non-Hazardous	Medium
03 01 04* sawdust, shavings, cuttings, wood, particle board and veneer containing dangerous substances	Hazardous	High
03 01 05 sawdust, shavings, cuttings, wood, particle board and veneer other than those mentioned in 03 01 04	Non-Hazardous	Medium

SCOTTISH ENVIRONMENT PROTECTION AGENCY

EWC description	Waste Classification	Charging Classification
03 01 99 wastes not otherwise specified	Non-Hazardous	Medium
03 02 01* non-halogenated organic wood preservatives	Hazardous	High
03 02 02* organochlorinated wood preservatives	Hazardous	High
03 02 03* organometallic wood preservatives	Hazardous	High
03 02 04* inorganic wood preservatives	Hazardous	High
03 02 05* other wood preservatives containing dangerous substances	Hazardous	High
03 02 99 wood preservatives not otherwise specified	Non-Hazardous	Medium
03 03 01 waste bark and wood	Non-Hazardous	Medium
03 03 02 green liquor sludge (from recovery of cooking liquor)	Non-Hazardous	Medium
03 03 05 de-inking sludges from paper recycling	Non-Hazardous	Medium
03 03 07 mechanically separated rejects from pulping of waste paper and cardboard	Non-Hazardous	Medium
03 03 08 wastes from sorting of paper and cardboard destined for recycling	Non-Hazardous	Medium
03 03 09 lime mud waste	Non-Hazardous	Medium
03 03 10 fibre rejects, fibre, filler and coating sludges from mechanical separation	Non-Hazardous	Medium
03 03 11 sludges from on-site effluent treatment other than those mentioned in 03 03 10	Non-Hazardous	Medium
03 03 99 wastes not otherwise specified	Non-Hazardous	Medium
04 01 01 fleshings and lime split wastes	Non-Hazardous	Medium

SCOTTISH ENVIRONMENT PROTECTION AGENCY

EWC description	Waste Classification	Charging Classification
04 01 02 liming waste	Non-Hazardous	Medium
04 01 03* degreasing wastes containing solvents without a liquid phase	Hazardous	High
04 01 04 tanning liquor containing chromium	Non-Hazardous	Medium
04 01 05 tanning liquor free of chromium	Non-Hazardous	Medium
04 01 06 sludges, in particular from on-site effluent treatment containing chromium	Non-Hazardous	Medium
04 01 07 sludges, in particular from on-site effluent treatment free of chromium	Non-Hazardous	Medium
04 01 08 waste tanned leather (blue sheetings, shavings, cuttings, buffing dust) containing chromium	Non-Hazardous	Medium
04 01 09 wastes from dressing and finishing	Non-Hazardous	Medium
04 01 99 wastes not otherwise specified	Non-Hazardous	Medium
04 02 09 wastes from composite materials (impregnated textile, elastomer, plastomer)	Non-Hazardous	Medium
04 02 10 organic matter from natural products (e.g. grease, wax)	Non-Hazardous	Medium
04 02 14* wastes from finishing containing organic solvents	Hazardous	High
04 02 15 wastes from finishing other than those mentioned in 14 02 14	Non-Hazardous	Medium
04 02 16* dyestuffs and pigments containing dangerous substances	Hazardous	High
04 02 17 dyestuffs and pigments other than those mentioned in 04 02 16	Non-Hazardous	Medium
04 02 19* sludges from on-site effluent treatment containing dangerous substances	Hazardous	High

SCOTTISH ENVIRONMENT PROTECTION AGENCY

EWC description	Waste Classification	Charging Classification
04 02 20 sludges from on-site effluent treatment other than those mentioned in 04 02 19	Non-Hazardous	Medium
04 02 21 wastes from unprocessed textile fibres	Non-Hazardous	Medium
04 02 22 wastes from processed textile fibres	Non-Hazardous	Medium
04 02 99 wastes not otherwise specified	Non-Hazardous	Medium
05 01 02* desaltercsudges	Hazardous	High
05 01 03 tank bottom sludges	Hazardous	High
05 01 04* acid alkyl sludges	Hazardous	High
05 01 05* oil spills	Hazardous	High
05 01 06* oily sludges from maintenance operations fo the plant or equipment	Hazardous	High
05 01 07* acid tars	Hazardous	High
05 01 08* others tars	Hazardous	High
05 01 09* sludges from on-site effluent treatment containing dangerous substances	Hazardous	High
05 01 10 sludges from on-site effluent treatment other than those mentioned in 05 01 09	Non-Hazardous	Medium
05 01 11* wastes from cleaning of fuels with bases	Hazardous	High
05 01 12* oil containing acids	Hazardous	High
05 01 13 boiler feedwatersludges	Non-Hazardous	Medium
05 01 14 wastes from cooling columns	Non-Hazardous	Medium
05 01 15* spent filter clays	Hazardous	High
05 01 16 sulphur-containing wastes from petroluem desulphurisation	Non-Hazardous	Medium

SCOTTISH ENVIRONMENT PROTECTION AGENCY

EWC description	Waste Classification	Charging Classification
05 01 17 bitumen	Non-Hazardous	Medium
05 01 99 wastes not otherwise specified	Non-Hazardous	Medium
05 06 01* acid tars	Hazardous	High
05 06 03* other tars	Hazardous	High
05 06 04 wastes from cooling columns	Non-Hazardous	Medium
05 06 99 wastes not otherwise specified	Non-Hazardous	Medium
05 07 01* wastes containing mercury	Hazardous	High
05 07 02 wastes containing sulphur	Non-Hazardous	Medium
05 07 99 wastes not otherwise specified	Non-Hazardous	Medium
06 01 01* sulphuric acid and sulphurous acid	Hazardous	High
06 01 02* hydrochloric acid	Hazardous	High
06 01 03* hydroflouric acid	Hazardous	High
06 01 04* phosphoric and phosphorous acid	Hazardous	High
06 01 05* nitric acid and nitrous acid	Hazardous	High
06 01 06* other acids	Hazardous	High
06 01 99 wastes not otherwise specified	Non-Hazardous	Medium
06 02 01* calcium hydroxide	Hazardous	High
06 02 03* ammonium hydroxide	Hazardous	High
06 02 04* sodium and potassium hydroxide	Hazardous	High
06 02 05* other bases	Hazardous	High
06 02 99 wastes not otherwise specified	Non-Hazardous	Medium
06 03 11* solid salts and solutions containing cyanides	Hazardous	High

SCOTTISH ENVIRONMENT PROTECTION AGENCY

EWC description	Waste Classification	Charging Classification
06 03 13* solid salts and solutions containing heavy metals	Hazardous	High
06 03 14 solid salts and solutions other than those mentioned in 06 03 11 and 06 03 13	Non-Hazardous	Medium
06 03 15* metallic oxides containing heavy metals	Hazardous	High
06 03 16 metallic oxides other than those mentioned in 06 03 15	Non-Hazardous	Medium
06 03 99 wastes not otherwise specified	Non-Hazardous	Medium
06 04 03* wastes containing arsenic	Hazardous	High
06 04 04* wastes containing mercury	Hazardous	High
06 04 05* wastes containing other heavy metals	Hazardous	High
06 04 99 wastes not otherwise specified	Non-Hazardous	Medium
06 05 02* sludges from on-site effluent treatment containing dangerous substances	Hazardous	High
06 05 03 sludges from on-site effluent treatment other than those mentioned on 06 05 02	Non-Hazardous	Medium
06 06 02* wastes containing dangerous sulphides	Hazardous	High
06 06 03 wastes containing sulphides other than those mentioned in 06 05 02	Non-Hazardous	Medium
06 06 99 wastes not otherwise specified	Non-Hazardous	Medium
06 07 01* wastes containing asbestos from electrolysis	Hazardous	High
06 07 02* activated carbon from chlorine production	Hazardous	High
06 07 03* barium sulphate sludge containing mercury	Hazardous	High

SCOTTISH ENVIRONMENT PROTECTION AGENCY

EWC description	Waste Classification	Charging Classification
06 07 04* solutions and acids, e.g contact acid	Hazardous	High
06 07 99 wastes not otherwise specified	Non-Hazardous	Medium
06 08 02* wastes containing dangerous silicones	Hazardous	High
06 08 99 wastes not otherwise specified	Non-Hazardous	Medium
06 09 02 phosphorous slag	Non-Hazardous	Medium
06 09 03* calcium-based reaction wastes containing or contaminated with dangerous substances	Hazardous	High
06 09 04 calcium-based reaction wastes other than those mentioned in 06 09 03	Non-Hazardous	Medium
06 09 99 wastes not otherwise specified	Non-Hazardous	Medium
06 10 02* wastes containing dangerous substances	Hazardous	High
06 10 99 wastes not otherwise specified	Non-Hazardous	Medium
06 11 01 calcium-based reaction wastes fro titanium dioxide production	Non-Hazardous	Medium
06 11 99 wastes not otherwise specified	Non-Hazardous	Medium
06 13 01* inorganic plant protection products, wood-preserving agents and other biocides	Hazardous	High
06 13 02* spent activated carbon (except 06 07 02)	Hazardous	High
06 13 03 carbon black	Non-Hazardous	Medium
06 13 04* wastes from asbestos processing	Hazardous	High
06 13 05* soot	Hazardous	High
06 13 99 wastes not otherwise specified	Non-Hazardous	Medium

SCOTTISH ENVIRONMENT PROTECTION AGENCY

EWC description	Waste Classification	Charging Classification
07 01 01* aqueous washing liquids and mother liquors	Hazardous	High
07 01 03* organic halogenated solvents, washing liquids and mother liquors	Hazardous	High
07 01 04* other organic solvents, washing liquids and mother liquors	Hazardous	High
07 01 07* halogenated still bottoms and reaction residues	Hazardous	High
07 01 08* other still bottoms and reaction residues	Hazardous	High
07 01 09* halogenated filter cakes and spent absorbents	Hazardous	High
07 01 10* other filter cakes and spent absorbents	Hazardous	High
07 01 11* sludges from on-site effluent treatment containing dangerous substances	Hazardous	High
07 01 12 sludges from on-site effluent treatment other than those mentioned in 07 01 11	Non-Hazardous	Medium
07 01 99 wastes not otherwise specified	Non-Hazardous	Medium
07 02 01* aqueous washing liquids and mother liquors	Hazardous	High
07 02 03* organic halogenated solvents, washing liquids and mother liquors	Hazardous	High
07 02 04* other organic solvents, washing liquids and mother liquors	Hazardous	High
07 02 07* halogenated still bottoms and reaction residues	Hazardous	High
07 02 08* other still bottoms and reaction residues	Hazardous	High
07 02 09* halogenated filter cakes and spent absorbents	Hazardous	High
07 02 10* other filter cakes and spent absorbents	Hazardous	High

SCOTTISH ENVIRONMENT PROTECTION AGENCY

EWC description	Waste Classification	Charging Classification
07 02 11* sludges from on-site effluent treatment containing dangerous substances	Hazardous	High
07 02 12 sludges from on-site effluent treatment other than those mentioned on 07 02 11	Non-Hazardous	Medium
07 02 13 waste plastic	Non-Hazardous	Medium
07 02 14* wastes from additives containing dangerous substances	Hazardous	High
07 02 15 wastes from additives other than those mentioned in 07 02 14	Non-Hazardous	Medium
07 02 16* wastes containing dangerous silicones	Hazardous	High
07 02 17 wastes containing silicones other than those mentioned in 07 02 16	Non-Hazardous	Medium
07 02 99 wastes not otherwise specified	Non-Hazardous	Medium
07 03 01* aqueous washing liquids and mother liquors	Hazardous	High
07 03 03* organic halogenated solvents, washing liquids and mother liquors	Hazardous	High
07 03 04* other organic solvents, washing liquids and mother liquors	Hazardous	High
07 03 07* halogenated still bottoms and reaction residues	Hazardous	High
07 03 08* other still bottoms and reaction residues	Hazardous	High
07 03 09* halogenated filter cakes and spent absorbents	Hazardous	High
07 03 10* other filter cakes and spent absorbents	Hazardous	High
07 03 11* sludges from on-site effluent treatment containing dangerous substances	Hazardous	High
07 03 12 sludges from on-site effluent	Non-Hazardous	Medium

SCOTTISH ENVIRONMENT PROTECTION AGENCY

EWC description	Waste Classification	Charging Classification
treatment other than those mentioned in 07 03 11		
07 03 99 wastes not otherwise specified	Non-Hazardous	Medium
07 04 01* aqueous washing liquids and mother liquors	Hazardous	High
07 04 03* organic halogenated solvents, washing liquids and mother liquors	Hazardous	High
07 04 04* other organic solvents, washing liquids and mother liquors	Hazardous	High
07 04 07* halogenated still bottoms and reaction residues	Hazardous	High
07 04 08* other still bottoms and reaction residues	Hazardous	High
07 04 09* halogenated filter cakes and spent absorbents	Hazardous	High
07 04 10* other filter cakes and spent absorbents	Hazardous	High
07 04 11* sludges from on-site effluent treatment containing dangerous substances	Hazardous	High
07 04 12 sludges from on-site effluent treatment other than those mentioned in 07 04 11	Non-Hazardous	Medium
07 04 13* solid wastes containing dangerous substances	Hazardous	High
07 04 99 wastes not otherwise specified	Non-Hazardous	Medium
07 05 01* aqueous washing liquids and mother liquors	Hazardous	High
07 05 03* organic halogenated solvents, washing liquids and mother liquors	Hazardous	High
07 05 04* other organic solvents, washing liquids and mother liquors	Hazardous	High
07 05 07* halogenated still bottoms and reaction residues	Hazardous	High

SCOTTISH ENVIRONMENT PROTECTION AGENCY

EWC description	Waste Classification	Charging Classification
07 05 08* other still bottoms and reaction residues	Hazardous	High
07 05 09* halogenated filter cakes and spent absorbents	Hazardous	High
07 05 10* other filter cakes and spent absorbents	Hazardous	High
07 05 11* sludges from on-site effluent treatment containing dangerous substances	Hazardous	High
07 05 12 sludges from on-site effluent treatment other than those mentioned in 07 05 11	Non-Hazardous	Medium
07 05 13* solid wastes containing dangerous substances	Hazardous	High
07 05 14 solid wastes other than those mentioned in 07 05 13	Non-Hazardous	Medium
07 05 99 wastes not otherwise specified	Non-Hazardous	Medium
07 06 01* aqueous washing liquids and mother liquors	Hazardous	High
07 06 03* organic halogenated solvents, washing liquids and mother liquors	Hazardous	High
07 06 04* other organic solvents, washing liquids and mother liquors	Hazardous	High
07 06 07* halogenated still bottoms and reaction residues	Hazardous	High
07 06 08* other still bottoms and reaction residues	Hazardous	High
07 06 09* halogenated filter cakes and spent absorbents	Hazardous	High
07 06 10* other filter cakes and spent absorbents	Hazardous	High
07 06 11* sludges from on-site effluent treatment containing dangerous substances	Hazardous	High

SCOTTISH ENVIRONMENT PROTECTION AGENCY

EWC description	Waste Classification	Charging Classification
07 06 12 sludges from on-site effluent treatment other than those mentioned in 07 06 11	Non-Hazardous	Medium
07 06 99 wastes not otherwise specified	Non-Hazardous	Medium
07 07 01* aqueous washing liquids and mother liquors	Hazardous	High
07 07 03* organic halogenated solvents, washing liquids and mother liquors	Hazardous	High
07 07 04* other organic solvents, washing liquids and mother liquors	Hazardous	High
07 07 07* halogenated still bottoms and reaction residues	Hazardous	High
07 07 08* other still bottoms and reaction residues	Hazardous	High
07 07 09* halogenated filter cakes and spent absorbents	Hazardous	High
07 07 10* other filter cakes and spent absorbents	Hazardous	High
07 07 11* sludges from on-site effluent treatment containing dangerous substances	Hazardous	High
07 07 12 sludges from on-site effluent treatment other than those mentioned in 07 07 11	Non-Hazardous	Medium
07 07 99 wastes not otherwise specified	Non-Hazardous	Medium
08 01 11* waste paint and varnish containing organic solvents or other dangerous substances	Hazardous	High
08 01 12 waste paint and varnish other than those mentioned in 08 01 11	Non-Hazardous	Medium
08 01 13* sludges from paint or varnish containing organic solvents or other dangerous substances	Hazardous	High
08 01 14 sludges from paint or varnish other than those mentioned in 08 01 13	Non-Hazardous	Medium

SCOTTISH ENVIRONMENT PROTECTION AGENCY

EWC description	Waste Classification	Charging Classification
08 01 15* aqueous sludges containing paint or varnish containing organic solvents or other dangerous substances	Hazardous	High
08 01 16 aqueous sludges containing paint or varnish other than those mentioned in 08 01 15	Non-Hazardous	Medium
08 01 17* wastes from paint or varnish removal containing organic solvents or other dangerous substances	Hazardous	High
08 01 18 wastes from paint or varnish removal other than those mentioned in 08 01 17	Non-Hazardous	Medium
08 01 19* aqueous suspensions containing paint or varnish containing organic solvents or other dangerous substances	Hazardous	High
08 01 20 aqueous suspensions containing paint or varnish other than those mentioned in 08 01 19	Non-Hazardous	Medium
08 01 21* waste paint or varnish remover	Hazardous	High
08 02 01 waste coating powders	Non-Hazardous	Medium
08 02 02 aqueous sludges containing ceramic materials	Non-Hazardous	Medium
08 02 03 aqueous suspensions containing ceramic materials	Non-Hazardous	Medium
08 02 99 wastes not otherwise specified	Non-Hazardous	Medium
08 03 07 aqueous sludges containing ink	Non-Hazardous	Medium
08 03 08 aqueous liquid waste containing ink	Non-Hazardous	Medium
08 03 12* waste ink containing dangerous substances	Hazardous	High
08 03 13 waste ink other than those mentioned in 08 03 12	Non-Hazardous	Medium
08 03 14* ink sludges containing dangerous substances	Hazardous	High

SCOTTISH ENVIRONMENT PROTECTION AGENCY

EWC description	Waste Classification	Charging Classification
08 03 15 ink sludges other than those mentioned in 08 03 14	Non-Hazardous	Medium
08 03 16* waste etching solutions	Hazardous	High
08 03 17* waste printing toner containing dangerous substances	Hazardous	High
08 03 18 waste printing toner other than those mentioned in 08 03 17	Non-Hazardous	Medium
08 03 19* disperse oil	Hazardous	High
08 03 99 wastes not otherwise specified	Non-Hazardous	Medium
08 04 09* waste adhesives and sealants containing organic solvents or other dangerous substances	Hazardous	High
08 04 10 waste adhesives and sealants other than those mentioned in 08 04 09	Non-Hazardous	Medium
08 04 11* adhesive and sealant sludges containing organic solvents or other dangerous substances	Hazardous	High
08 04 12 adhesive and sealants sludges other than those mentioned in 08 04 11	Non-Hazardous	Medium
08 04 13* aqueous sludges containing adhesives or sealants containing organic solvents or other dangerous substances	Hazardous	High
08 04 14 aqueous sludges containing adhesives or sealants other than those mentioned in 08 04 13	Non-Hazardous	Medium
08 04 15* aqueous liquid waste containing adhesives or sealants containing organic solvents or other dangerous substances	Hazardous	High
08 04 16 aqueous liquid waste containing adhesives or sealants other than those mentioned in 08 04 15	Non-Hazardous	Medium
08 04 17* rosin oil	Hazardous	High
08 04 99 wastes not otherwise specified	Non-Hazardous	Medium

SCOTTISH ENVIRONMENT PROTECTION AGENCY

EWC description	Waste Classification	Charging Classification
08 05 01* waste isocyanates	Hazardous	High
09 01 01* water-based developer and activator solutions	Hazardous	High
09 01 02* water-based offset plate develop solutions	Hazardous	High
09 01 03* solvent-based developer solutions fixer solutions	Hazardous	High
09 01 04* fixer solutions	Hazardous	High
09 01 05* bleach solutions	Hazardous	High
09 01 06* wastes containing silver from on-site treatment of photographic wastes	Hazardous	High
09 01 07 photographic film and paper containing silver or silver compounds	Non-Hazardous	Medium
09 01 08 photographic film and paper free of silver or silver compounds	Non-Hazardous	Medium
09 01 10 single use cameras without batteries	Non-Hazardous	Medium
09 01 11* single use cameras containing batteries included in 16 06 01, 16 06 02 or 16 06 03	Hazardous	High
09 01 12 single use cameras containing batteries other than those mentioned in 09 01 11	Non-Hazardous	Medium
09 01 13* aqueous liquid waste from on-site reclamation of silver other than those mentioned in 09 01 06	Hazardous	High
09 01 99 wastes not otherwise specified	Non-Hazardous	Medium
10 01 01 bottom ash, slag and boiler dust (excluding boiler dust mentioned in 10 01 04)	Non-Hazardous	Low
10 01 02 coal fly ash	Non-Hazardous	Medium
10 01 03 fly ash from peat and untreated wood	Non-Hazardous	Medium

SCOTTISH ENVIRONMENT PROTECTION AGENCY

EWC description	Waste Classification	Charging Classification
10 01 04* oil fly ash and boiler dust	Hazardous	High
10 01 05 calcium-based reaction wastes from flue gas desulphurisation in solid form	Non-Hazardous	Medium
10 01 07 calcium-based reaction wastes from flue gas desulphurisation in sludge form	Non-Hazardous	Medium
10 01 09* sulphuric acid	Hazardous	High
10 01 13* fly ash from emulsified hydrocarbons used as fuel	Hazardous	High
10 01 14* bottom ash, slag and boiler dust from co-incineration containing dangerous substances	Hazardous	High
10 01 15 bottom ash, slag and boiler dust from co-incineration other than those mentioned in 10 01 14	Non-Hazardous	Medium
10 01 16* fly ash from co-incineration containing dangerous substances	Hazardous	High
10 01 17 fly ash from co-incineration other than those mentioned in 10 01 16	Non-Hazardous	Low
10 01 18* wastes from gas cleaning containing dangerous substances	Hazardous	High
10 01 19 wastes from gas cleaning other than those mentioned in 10 01 05, 10 01 07 and 10 01 18	Non-Hazardous	Medium
10 01 20* sludges from on-site effluent treatment containing dangerous substances	Hazardous	High
10 01 21 sludges from on-site effluent treatment other than those mentioned in 10 01 20	Non-Hazardous	Medium
10 01 22* aqueous sludges from boiler cleansing containing dangerous substances	Hazardous	High
10 01 23 aqueous sludges from boiler cleansing other than those mentioned in 10 01 22	Non-Hazardous	Medium

SCOTTISH ENVIRONMENT PROTECTION AGENCY

EWC description	Waste Classification	Charging Classification
10 01 24 sands from fluidised beds	Non-Hazardous	Medium
10 01 25 wastes from fuel storage and preparation of coal fired power plants	Non-Hazardous	Medium
10 01 26 wastes from cooling water treatment	Non-Hazardous	Medium
10 01 99 wastes not otherwise specified	Non-Hazardous	Medium
10 02 01 wastes from the processing of slag	Non-Hazardous	Medium
10 02 02 unprocessed slag	Non-Hazardous	Medium
10 02 07* solid wastes from gas treatment containing dangerous substances	Hazardous	High
10 02 08 solid wastes from gas treatment other than those mentioned in 10 02 07	Non-Hazardous	Medium
10 02 10 mill scales	Non-Hazardous	Medium
10 02 11* wastes from cooling water treatment containing oil	Hazardous	High
10 02 12 wastes from cooling water treatment other than those mentioned in 10 02 07	Non-Hazardous	Medium
10 02 13* sludges and filter cakes from gas treatment containing dangerous substances	Hazardous	High
10 02 14 sludges and filter cake other than those mentioned in 10 02 13	Non-Hazardous	Medium
10 02 15 other sludges and filter cakes	Non-Hazardous	Medium
10 02 99 wastes not otherwise specified	Non-Hazardous	Medium
10 03 02 anode scraps	Non-Hazardous	Medium
10 03 04* primary production slags	Hazardous	High

SCOTTISH ENVIRONMENT PROTECTION AGENCY

EWC description	Waste Classification	Charging Classification
10 03 05 waste alumina	Non-Hazardous	Medium
10 03 08* salt slags from secondary production	Hazardous	High
10 03 09* black drosses from secondary production	Hazardous	High
10 03 15* skimmings that are flammable or emit, upon contact with water, flammable gases in dangerous quantities	Hazardous	High
10 03 16 skimmings other than those mentioned in 10 03 15	Non-Hazardous	Medium
10 03 17* tar-containing wastes from anode manufacture	Hazardous	High
10 03 18 carbon-containing wastes from anode manufacture other than those mentioned in 10 30 17	Non-Hazardous	Medium
10 03 19* flue-gas dust containing dangerous substances	Hazardous	High
10 03 20 flue-gas dust other than those mentioned in 10 03 19	Non-Hazardous	Medium
10 03 21* other particulates and dust (including ball-mill dust) containing dangerous substances	Hazardous	High
10 03 22 other particulates and dust (including ball-mill dust) other than those mentioned in 10 03 21	Non-Hazardous	Medium
10 03 23* solid wastes from gas treatment containing dangerous substances	Hazardous	High
10 03 24 solid wastes from gas treatment other than those mentioned in 10 03 23	Non-Hazardous	Medium
10 03 25* sludges and filter cakes from gas treatment containing dangerous substances	Hazardous	High
10 03 26 sludges and filter cakes from gas treatment other than those mentioned in 10 03 25	Non-Hazardous	Medium

SCOTTISH ENVIRONMENT PROTECTION AGENCY

EWC description	Waste Classification	Charging Classification
10 03 27* wastes from cooling-water treatment containing oil	Hazardous	High
10 03 28 wastes from cooling-water treatment other than those mentioned in 10 03 27	Non-Hazardous	Medium
10 03 29* wastes from treatment of salt slags and black drosses containing dangerous substances	Hazardous	High
10 03 30 wastes from treatment of salt slags and black drosses other than those mentioned in 10 03 29	Non-Hazardous	Medium
10 03 99 wastes not otherwise specified	Non-Hazardous	Medium
10 04 01* slag from primary and secondary production	Hazardous	High
10 04 02* dross and skimmings from primary and secondary production	Hazardous	High
10 04 03* calcium arsenate	Hazardous	High
10 04 04* flue-gas dust	Hazardous	High
10 04 05* other particulates and dust	Hazardous	High
10 04 06* solid wastes from gas treatment	Hazardous	High
10 04 07* sludges and filter cakes from gas treatment	Hazardous	High
10 04 09* wastes from cooling-water treatment containing oil	Hazardous	High
10 04 10 wastes from cooling-water treatment other than those mentioned in 10 04 09	Non-Hazardous	Medium
10 04 99 wastes not otherwise specified	Non-Hazardous	Medium
10 05 01 slags from primary and secondary production	Non-Hazardous	Medium
10 05 03* flue-gas dust	Hazardous	High
10 05 04 other particulates and dust	Non-Hazardous	Medium

SCOTTISH ENVIRONMENT PROTECTION AGENCY

EWC description	Waste Classification	Charging Classification
10 05 05* solid waste from gas treatment	Hazardous	High
10 05 06* sludges and filter cakes from gas treatment	Hazardous	High
10 05 08* wastes from cooling water treatment containing oil	Hazardous	High
10 05 09 wastes from cooling water treatment other than those mentioned in 10 05 08	Non-Hazardous	Medium
10 05 10* dross and skimmings that are flammable or emit, upon contact with water, flammable gases in dangerous quantities	Hazardous	High
10 05 11 dross and skimmings other than those mentioned in 10 05 10	Non-Hazardous	Medium
10 05 99 wastes not otherwise specified	Non-Hazardous	Medium
10 06 01 slags from primary and secondary production	Non-Hazardous	Medium
10 06 02 dross and skimmings from primary and secondary production	Non-Hazardous	Medium
10 06 03* flue-gas dust	Hazardous	High
10 06 04 other particulates and dust	Non-Hazardous	Medium
10 06 06* solid wastes from gas treatment	Hazardous	High
10 06 07* sludges and filter cakes from gas treatment	Hazardous	High
10 06 09* wastes from cooling-water treatment containing oil	Hazardous	High
10 06 10 wastes from cooling-water treatment other than those mentioned in 10 06 09	Non-Hazardous	Medium
10 06 99 wastes not otherwise specified	Non-Hazardous	Medium
10 07 01 slags from primary and secondary production	Non-Hazardous	Medium

SCOTTISH ENVIRONMENT PROTECTION AGENCY

EWC description	Waste Classification	Charging Classification
10 07 02 dross and skinnings from primary and secondary production	Non-Hazardous	Medium
10 07 03 solid wastes from gas treatment	Non-Hazardous	Medium
10 07 04 other particulates and dust	Non-Hazardous	Medium
10 07 05 sludges and filter cakes from gas treatment	Non-Hazardous	Medium
10 07 07* wastes from cooling-water treatment containing oil	Hazardous	High
10 07 08 wastes from cooling-water treatment other than those mentioned in 10 07 07	Non-Hazardous	Medium
10 07 99 wastes not otherwise specified	Non-Hazardous	Medium
10 08 04 particulates and dust	Non-Hazardous	Medium
10 08 08* salt slag from primary and secondary production	Hazardous	High
10 08 09 other slags	Non-Hazardous	Medium
10 08 10* dross and skimmings that are flammable or emit, upon contact with water, flammable gases in dangerous quantities	Hazardous	High
10 08 11 dross and skimmings other than those mentioned in 10 08 10	Non-Hazardous	Medium
10 08 12* tar-containing wastes from anode manufacture	Hazardous	High
10 08 13 carbon-containing wastes from anode manufacture other than those mentioned in 10 08 12	Non-Hazardous	Medium
10 08 14 anode scrap	Non-Hazardous	Medium
10 08 15 flue-gas dust containing dangerous substances	Hazardous	High
10 08 16* flue-gas dust other than those mentioned in 10 08 15	Non-Hazardous	Medium

SCOTTISH ENVIRONMENT PROTECTION AGENCY

EWC description	Waste Classification	Charging Classification
10 08 17 sludges and filter cakes from flue-gas treatment containing dangerous substances	Non-Hazardous	Medium
10 08 18* sludges and filter cakes from flue-gas treatment other than those mentioned in 10 08 17	Non-Hazardous	Medium
10 08 19 wastes from cooling-water treatment containing oil	Hazardous	High
10 08 20* wastes from cooling-water treatment other than those mentioned in 10 08 19	Non-Hazardous	Medium
10 08 99 wastes not otherwise specified	Non-Hazardous	Medium
10 09 03 furnace slag	Non-Hazardous	Medium
10 09 05* casting cores and moulds which have not undergone pouring containing dangerous substances	Hazardous	High
10 09 06 casting cores and moulds which have not undergone pouring other than those mentioned in 10 09 05	Non-Hazardous	Medium
10 09 07* casting cores and moulds which have undergone pouring containing dangerous substances	Hazardous	High
10 09 08 casting cores and moulds which have undergone pouring other than those mentioned in 10 09 07	Non-Hazardous	Medium
10 09 09* flue-gas dust containing dangerous substances	Hazardous	High
10 09 10 flue-gas dust other than those mentioned in 10 09 09	Non-Hazardous	Medium
10 09 11* other particulates containing dangerous substances	Hazardous	High
10 09 12 other particulates other than those mentioned in 10 09 11	Non-Hazardous	Medium
10 09 13* waste binders containing dangerous substances	Hazardous	High

SCOTTISH ENVIRONMENT PROTECTION AGENCY

EWC description	Waste Classification	Charging Classification
10 09 14 waste binders other than those mentioned in 10 09 13	Non-Hazardous	Medium
10 09 15* waste crack-indicating agent containing dangerous substances	Hazardous	High
10 09 16 waste crack indicating substances other than those mentioned in 10 09 15	Non-Hazardous	Medium
10 09 99 waste not otherwise specified	Non-Hazardous	Medium
10 10 03 furnace slag	Non-Hazardous	Medium
10 10 05* casting cores and moulds which have not undergone pouring, containing dangerous substances	Hazardous	High
10 10 06 casting cores and moulds which have not undergone pouring other than those mentioned in 10 10 05	Non-Hazardous	Medium
10 10 07* casting cores and moulds which have undergone pouring, containing dangerous substances	Hazardous	High
10 10 08 casting cores and moulds which have undergone pouring other than those mentioned in 10 10 07	Non-Hazardous	Medium
10 10 09* flue-gas dust containing dangerous substances	Hazardous	High
10 10 10 flue-gas dust other than those mentioned in 10 10 09	Non-Hazardous	Medium
10 10 11* other particulates containing dangerous substances	Hazardous	High
10 10 12 other particulates other than those mentioned on 10 10 10	Non-Hazardous	Medium
10 10 13* waste binders containing dangerous substances	Hazardous	High
10 10 14 waste binders other than those mentioned in 10 10 13	Non-Hazardous	Medium
10 10 15* waste crack-indicating agent containing dangerous substances	Hazardous	High

SCOTTISH ENVIRONMENT PROTECTION AGENCY

EWC description	Waste Classification	Charging Classification
10 10 16 waste crack-indicating agent other than those mentioned in 10 10 15	Non-Hazardous	Medium
10 10 99 wastes not otherwise specified	Non-Hazardous	Medium
10 11 03 waste glass-based fibrous materials	Inert	Low
10 11 05 particulates and dust	Non-Hazardous	Medium
10 11 09* waste preparation mixture before thermal processing, containing dangerous substances	Hazardous	High
10 11 10 waste preparation mixture before thermal processing other than those mentioned in 10 11 09	Non-Hazardous	Medium
10 11 11* waste glass in small particles and glass powder containing metals (e.g cathode ray tubes)	Hazardous	High
10 11 12 waste glass other than those mentioned in 10 11 11	Non-Hazardous	Medium
10 11 13* glass-polishing and grinding sludge containing dangerous substances	Hazardous	High
10 11 14 glass-polishing and grinding sludge other than those mentioned in 10 11 13	Non-Hazardous	Medium
10 11 15* solid wastes from flue-gas treatment containing dangerous substances	Hazardous	High
10 11 16 solid wastes from flue-gas treatment other than those mentioned in 10 11 15	Non-Hazardous	Medium
10 11 17* sludges and filter cakes from flue-gas treatment containing dangerous substances	Hazardous	High
10 11 18 sludges and filter cakes from flue-gas treatment other than those mentioned in 10 11 17	Non-Hazardous	Medium
10 11 19* solid wastes from on-site effluent treatment containing dangerous	Hazardous	High

SCOTTISH ENVIRONMENT PROTECTION AGENCY

EWC description	Waste Classification	Charging Classification
substances		
10 11 20 solid wastes from on-site effluent treatment other than those mentioned in 10 11 19	Non-Hazardous	Medium
10 11 99 wastes not otherwise specified	Non-Hazardous	Medium
10 12 01 waste preparation mixture before thermal processing	Non-Hazardous	Medium
10 12 03 particulates and dust	Non-Hazardous	Medium
10 12 05 sludges and filter cakes from gas treatment	Non-Hazardous	Medium
10 12 06 discarded moulds	Non-Hazardous	Medium
10 12 08 waste ceramics, bricks, tiles and construction products (after thermal processing)	Non-Hazardous	Medium
10 12 09* solid wastes from gas treatment containing dangerous substances	Hazardous	High
10 12 10 solid waste from gas treatment other than those mentioned in 10 12 09	Non-Hazardous	Medium
10 12 11* wastes from glazing containing heavy metals	Hazardous	High
10 12 12 wastes from glazing other than those mentioned in 10 12 11	Non-Hazardous	Medium
10 12 13 sludge from on-site effluent treatment	Non-Hazardous	Medium
10 12 99 wastes not otherwise specified	Non-Hazardous	Medium
10 13 01 waste preparation mixture before thermal processing	Non-Hazardous	Medium
10 13 04 wastes from calcination and hydration of lime	Non-Hazardous	Medium
10 13 06 particulates and dust (except 10 13 12 and 10 13 13)	Non-Hazardous	Medium

SCOTTISH ENVIRONMENT PROTECTION AGENCY

EWC description	Waste Classification	Charging Classification
10 13 07 sludges and filter cakes from gas treatment	Non-Hazardous	Medium
10 13 09* wastes from asbestos-cement manufacture containing asbestos	Hazardous	High
10 13 10 wastes from asbestos-cement manufacture other than those mentioned in 10 13 09	Non-Hazardous	Medium
10 13 11 wastes from cement-based composite materials other than those mentioned in 10 13 09 and 10 13 10	Non-Hazardous	Medium
10 13 12* solid wastes from gas treatment containing dangerous substances	Hazardous	High
10 13 13 solid wastes from gas treatment other than those mentioned in 10 13 12	Non-Hazardous	Medium
10 13 14 waste concrete and concrete sludge	Non-Hazardous	Medium
10 13 99 wastes not otherwise specified	Non-Hazardous	Medium
10 14 01* waste from gas cleaning containing mercury	Hazardous	High
11 01 05* pickling acids	Hazardous	High
11 01 06* acids not otherwise specified	Hazardous	High
11 01 07* pickling bases	Hazardous	High
11 01 08* phosphatising sludges	Hazardous	High
11 01 09* sludges and filter cakes containing dangerous substances	Hazardous	High
11 01 10 sludges and filter cakes other than those mentioned in 11 01 09	Non-Hazardous	Medium
11 01 11* aqueous rinsing liquids containing dangerous substances	Hazardous	High
11 01 12 aqueous rinsing liquids other than those mentioned in 11 01 11	Non-Hazardous	Medium

SCOTTISH ENVIRONMENT PROTECTION AGENCY

EWC description	Waste Classification	Charging Classification
11 01 13* degreasing wastes containing dangerous substances	Hazardous	High
11 01 14 degreasing wastes other than those mentioned in 11 01 13	Non-Hazardous	Medium
11 01 15* eluate and sludges from membrane systems or ion exchange systems containing dangerous substances	Hazardous	High
11 01 16* saturated or spent ion exchange resins	Hazardous	High
11 01 98* other wastes containing dangerous substances	Hazardous	High
11 01 99* waste not otherwise specified	Non-Hazardous	Medium
11 02 02* sludges from zinc hydrometallurgy (including jarosite, goethite)	Hazardous	High
11 02 03 wastes from production of anodes for aqueous electrolytical processes	Non-Hazardous	Medium
11 02 05* wastes from copper hydrometallurgy processes containing dangerous substances	Hazardous	High
11 02 06 wastes from copper hydrometallurgy processes other than those mentioned in 11 02 05	Non-Hazardous	Medium
11 02 07* other wastes containing dangerous substances	Hazardous	High
11 02 99 wastes not otherwise specified	Non-Hazardous	Medium
11 03 01* wastes containing cyanide	Hazardous	High
11 03 02* other wastes	Hazardous	High
11 05 01 hard zinc	Non-Hazardous	Medium
11 05 02 zinc ash	Non-Hazardous	Medium
11 05 03* solid wastes from gas	Hazardous	High

SCOTTISH ENVIRONMENT PROTECTION AGENCY

EWC description	Waste Classification	Charging Classification
treatment		
11 05 04* spent flux	Hazardous	High
11 05 99 wastes not otherwise specified	Non-Hazardous	Medium
12 01 01 ferrous metal filings and turnings	Non-Hazardous	Medium
12 01 02 ferrous metal dust and particles	Non-Hazardous	Medium
12 01 03 non-ferrous metal filings and turnings	Non-Hazardous	Medium
12 01 04 non-ferrous metal dust and particles	Non-Hazardous	Medium
12 01 05 plastic shavings and turnings	Non-Hazardous	Medium
12 01 06* mineral-based machining oils containing halogens (except emulsions and solutions)	Hazardous	High
12 01 07* mineral-based machining oils free of halogens (except emulsions and solutions)	Hazardous	High
12 01 08* machining emulsions and solutions containing halogens	Hazardous	High
12 01 09* machining emulsions and solutions free of halogens	Hazardous	High
12 01 10* synthetic machining oils	Hazardous	High
12 01 12* spent waxes and fats	Hazardous	High
12 01 13 welding wastes	Non-Hazardous	Medium
12 01 14* machining sludges containing dangerous substances	Hazardous	High
12 01 15 machining sludges other than those mentioned in 12 01 14	Non-Hazardous	Medium
12 01 16* waste blasting material containing dangerous substances	Hazardous	High
12 01 17 waste blasting materials other than those mentioned in 12 01 16	Non-Hazardous	Medium

SCOTTISH ENVIRONMENT PROTECTION AGENCY

EWC description	Waste Classification	Charging Classification
12 01 18* metal sludge (grinding, honing and lapping sludge) containing oil	Hazardous	High
12 01 19* readily biodegradable machining oil	Hazardous	High
12 01 20* spent grinding bodies and grinding materials containing dangerous substances	Hazardous	High
12 01 21 spent grinding bodies and grinding materials other than those mentioned in 12 01 20	Non-Hazardous	Medium
12 01 99 wastes not otherwise specified	Non-Hazardous	Medium
12 03 01* aqueous washing liquids	Hazardous	High
12 03 02* steam degreasing wastes	Hazardous	High
13 01 01* hydraulic oils, containing PCB's	Hazardous	High
13 01 04* chlorinated emulsions	Hazardous	High
13 01 05* non-chlorinated emulsions	Hazardous	High
13 01 09* mineral-based chlorinated hydraulic oils	Hazardous	High
13 01 10* mineral-based non-chlorinated hydraulic oils	Hazardous	High
13 01 11* synthetic hydraulic oils	Hazardous	High
13 01 12* readily biodegradable hydraulic oils	Hazardous	High
13 01 13* other hydraulic oils	Hazardous	High
13 02 04* mineral-based chlorinated engine, gear and lubricating oils	Hazardous	High
13 02 05* mineral-based non-chlorinated engine, gear and lubricating oils	Hazardous	High
13 02 06* synthetic engine, gear and lubricating oils	Hazardous	High
13 02 07* readily biodegradable engine, gear and lubricating oils	Hazardous	High

SCOTTISH ENVIRONMENT PROTECTION AGENCY

EWC description	Waste Classification	Charging Classification
13 02 08* other engine, gear and lubricating oils	Hazardous	High
13 03 01* insulating or heat transmission oils containing PCB's	Hazardous	High
13 03 06* mineral-based chlorinated insulating and heat transmission oils other than those mentioned in 13 03 01	Hazardous	High
13 03 07* mineral-based non-chlorinated insulating and heat transmission oils	Hazardous	High
13 03 08* synthetic insulating and heat transmission oils	Hazardous	High
13 03 09* readily biodegradable insulating and heat transmission oils	Hazardous	High
13 03 10* other insulating and heat transmission oils	Hazardous	High
13 04 01* bilge oils from inland navigation	Hazardous	High
13 04 02* bilge oils from jetty sewers	Hazardous	High
13 04 03* bilge oils from other navigation	Hazardous	High
13 05 01* solids from grit chambers and oil/water separators	Hazardous	High
13 05 02* sludges from oil/water separators	Hazardous	High
13 05 03* interceptor sludges	Hazardous	High
13 05 06* oil from oil/water separators	Hazardous	High
13 05 07* oily water from oil/water separators	Hazardous	High
13 05 08* mixtures of wastes from grit chambers and oil/water separators	Hazardous	High
13 07 01* fuel oil and diesel	Hazardous	High
13 07 02* petrol	Hazardous	High
13 07 03* other fuels (including mixtures)	Hazardous	High
13 08 01* desaltersludges or emulsions	Hazardous	High

SCOTTISH ENVIRONMENT PROTECTION AGENCY

EWC description	Waste Classification	Charging Classification
13 08 02* other emulsions	Hazardous	High
13 08 99* wastes not otherwise specified	Hazardous	High
14 06 01* chloroflourocarbons, HCFC, HFC	Hazardous	High
14 06 02* other halogenated solvents and solvent mixtures	Hazardous	High
14 06 03* other solvents and solvent mixtures	Hazardous	High
14 06 04* sludges or solid wastes containing halogenated solvents	Hazardous	High
14 06 05* sludges or solid wastes containing other solvents	Hazardous	High
15 01 01 paper and cardboard packaging	Non-Hazardous	Medium
15 01 02 plastic packaging	Non-Hazardous	Medium
15 01 03 wooden packaging	Non-Hazardous	Medium
15 01 04 metallic packaging	Non-Hazardous	Medium
15 01 05 composite packaging	Non-Hazardous	Medium
15 01 06 mixed packaging	Non-Hazardous	Medium
15 01 07 glass packaging	Inert	Low
15 01 09 textile packaging	Non-Hazardous	Medium
15 01 10* packaging containing residues of or contaminated by dangerous substances	Hazardous	High
15 01 11* metallic packaging containing a dangerous solid porous matrix (for example asbestos), including empty pressure containers	Hazardous	High
15 02 02* absorbents, filter materials (including oil filters not otherwise specified) wiping cloths, protective clothing contaminated by dangerous	Hazardous	High

SCOTTISH ENVIRONMENT PROTECTION AGENCY

EWC description	Waste Classification	Charging Classification
substances		
15 02 03 absorbents, filter materials, wiping cloths and protective clothing other than those mentioned in 15 02 02	Non-Hazardous	Medium
16 01 03 end-of-life tyres	Non-Hazardous	Medium
16 01 04* end-of-life vehicles	Hazardous	High
16 01 06 end-of-life vehicles, containing neither liquids nor other hazardous components	Non-Hazardous	Medium
16 01 07* oil filters	Hazardous	High
16 01 08* components containing mercury	Hazardous	High
16 01 09* components containing PCB's	Hazardous	High
16 01 10* explosive components (e.g. air bags)	Hazardous	High
16 01 11* brake pads containing asbestos	Hazardous	High
16 01 12 brake pads other than those mentioned in 16 01 11	Non-Hazardous	Medium
16 01 13* brake fluids	Hazardous	High
16 01 14* antifreeze fluids containing dangerous substances	Hazardous	High
16 01 15 antifreeze fluids other than those mentioned in 16 01 14	Non-Hazardous	Medium
16 01 16 tanks for liquefied gas	Non-Hazardous	Medium
16 01 17 ferrous metal	Non-Hazardous	Medium
16 01 18 non-ferrous metal	Non-Hazardous	Medium
16 01 19 plastic	Non-Hazardous	Medium
16 01 20 glass	Non-Hazardous	Medium

SCOTTISH ENVIRONMENT PROTECTION AGENCY

EWC description	Waste Classification	Charging Classification
16 01 21* hazardous components other than those mentioned in 16 01 07 to 16 01 11 and 16 01 13 and 16 01 14	Hazardous	High
16 01 22 components not otherwise specified	Non-Hazardous	Medium
16 01 99 wastes not otherwise specified	Non-Hazardous	Medium
16 02 09* transformers and capacitors containing PCB's	Hazardous	High
16 02 10* discarded equipment containing or contaminated by PCB's other than those mentioned in 16 02 09	Hazardous	High
16 02 11* discarded equipment containing chloroflourocarbons, HCFC, HFC	Hazardous	High
16 02 12* discarded equipment containing free asbestos	Hazardous	High
16 02 13* discarded equipment containing hazardous components other than those mentioned in 16 02 09 to 16 02 12	Hazardous	High
16 02 14 discarded equipment other than those mentioned in 16 02 09 to 16 02 13	Non-Hazardous	Medium
16 02 15* hazardous components removed from discarded equipment	Hazardous	High
16 02 16 components removed from discarded equipment other than those mentioned in 16 02 15	Non-Hazardous	Medium
16 03 03* inorganic wastes containing dangerous substances	Hazardous	High
16 03 04 inorganic wastes other than those mentioned in 16 03 03	Non-Hazardous	Medium
16 03 05* organic wastes containing dangerous substances	Hazardous	High
16 03 06 organic wastes other than those mentioned in 16 03 05	Non-Hazardous	Medium
16 04 01* waste ammunition	Hazardous	High

SCOTTISH ENVIRONMENT PROTECTION AGENCY

EWC description	Waste Classification	Charging Classification
16 04 02* fireworks wastes	Hazardous	High
16 04 03* other waste explosives	Hazardous	High
16 05 04* gases in pressure containers(including halons) containing dangerous substances	Hazardous	High
16 05 05 gases in pressure containers other than those mentioned in 16 05 04	Non-Hazardous	Medium
16 05 06* laboratory chemicals, consisting of or containing dangerous substances, including mixtures of laboratory chemicals	Hazardous	High
16 05 07* discarded inorganic chemicals consisting of or containing dangerous substances	Hazardous	High
16 05 08* discarded organic chemicals consisting of or containing dangerous substances	Hazardous	High
16 05 09 discarded chemicals other than those mentioned in 16 05 06, 16 05 07 or 16 05 08	Non-Hazardous	Medium
16 06 01* lead batteries	Hazardous	High
16 06 02* Ni-Cd batteries	Hazardous	High
16 06 03* mercury-containing batteries	Hazardous	High
16 06 04 alkaline batteries	Non-Hazardous	Medium
16 06 05 other batteries and accumulators	Non-Hazardous	Medium
16 06 06* separately collected electrolyte from batteries and accumulators	Hazardous	High
16 07 08* wastes containing oil	Hazardous	High
16 07 09* wastes containing other dangerous substances	Hazardous	High
16 07 99 wastes not otherwise specified	Non-Hazardous	Medium
16 08 01 spent catalysts containing gold,	Non-Hazardous	Medium

SCOTTISH ENVIRONMENT PROTECTION AGENCY

EWC description	Waste Classification	Charging Classification
silver, rhenium, rhodium, palladium, iridium or platinum (except 16 08 07)		
16 08 02* spent catalysts containing dangerous transition metals or dangerous transition metal compounds	Hazardous	High
16 08 03 spent catalysts containing transition metals or transition metal compounds not otherwise specified	Non-Hazardous	Medium
16 08 04 spent fluid catalytic cracking catalysts (except 16 08 07)	Non-Hazardous	Medium
16 08 05* spent catalysts containing phosphoric acid	Hazardous	High
16 08 06* spent liquids used as catalysts	Hazardous	High
16 08 07* spent catalysts contaminated with dangerous substances	Hazardous	High
16 09 01* permanganates, e.g. potassium permanganates	Hazardous	High
16 09 02* chromates, e.g. potassium chromate, potassium or sodium dichromate	Hazardous	High
16 09 03* peroxides, e.g. hydrogen peroxide	Hazardous	High
16 09 04* oxidising substances not otherwise specified	Hazardous	High
16 10 01* aqueous liquid wastes containing dangerous substances	Hazardous	High
16 10 02 aqueous liquid wastes other than those mentioned in 16 10 01	Non-Hazardous	Medium
16 10 03* aqueous concentrates containing dangerous substances	Hazardous	High
16 10 04 aqueous concentrates other than those mentioned in 16 10 03	Non-Hazardous	Medium
16 11 01* carbon-based linings and refractories from metallurgical processes containing dangerous substances	Hazardous	High

SCOTTISH ENVIRONMENT PROTECTION AGENCY

EWC description	Waste Classification	Charging Classification
16 11 02 carbon-based linings and refractories from metallurgical processes other than those mentioned in 16 11 01	Non-Hazardous	Medium
16 11 03* other linings and refractories from metallurgical processes containing dangerous substances	Hazardous	High
16 11 04 other linings and refractories from metallurgical processes other than those mentioned in 16 11 03	Non-Hazardous	Medium
16 11 05* linings and refractories from non-metallurgical processes containing dangerous substances	Hazardous	High
16 11 06 linings and refractories from non-metallurgical processes other than those mentioned in 16 11 05	Non-Hazardous	Medium
17 01 01 concrete	Non-Hazardous	Medium
17 01 02 bricks	Inert	Low
17 01 03 tiles and ceramics	Inert	Low
17 01 06* mixtures of, or separate fractions of concrete, bricks tiles and ceramics containing dangerous substances	Hazardous	High
17 01 07 mixtures of concrete, bricks, tiles and ceramics other than those mentioned in 17 01 06	Inert	Low
17 02 01 wood	Non-Hazardous	Medium
17 02 02 glass	Inert	Low
17 02 03 plastic	Non-Hazardous	Medium
17 02 04* glass, plastic and wood containing or contaminated with substances	Hazardous	High
17 03 01* bituminous mixtures containing coal tar	Hazardous	High
17 03 02 bituminous mixtures other than those mentioned in 17 03 01	Non-Hazardous	Medium

SCOTTISH ENVIRONMENT PROTECTION AGENCY

EWC description	Waste Classification	Charging Classification
17 03 03* coal tar and tarred products	Hazardous	High
17 04 01 copper, bronze, brass	Non-Hazardous	Medium
17 04 02 aluminium	Non-Hazardous	Medium
17 04 03 lead batteries	Non-Hazardous	Medium
17 04 04 zinc	Non-Hazardous	Medium
17 04 05 iron and steel	Non-Hazardous	Medium
17 04 06 tin	Non-Hazardous	Medium
17 04 07 mixed metals	Non-Hazardous	Medium
17 04 09* metal waste contaminated with dangerous substances	Hazardous	High
17 04 10* cables containing oil, coal tar and other dangerous substances	Hazardous	High
17 04 11 cables other than those mentioned in 17 04 10	Non-Hazardous	Medium
17 05 03* soil and stones containing dangerous substances	Hazardous	High
17 05 04 soil and stones other than those mentioned in 17 05 03	Inert	Low
17 05 05* dredging spoil containing dangerous substances	Hazardous	High
17 05 06 dredging spoil other than those mentioned in 17 05 05	Non-Hazardous	Medium
17 05 07* track ballast containing dangerous substances	Hazardous	High
17 05 08 track ballast other than those mentioned in 17 05 07	Non-Hazardous	Medium
17 06 01* insulating materials containing asbestos	Hazardous	High
17 06 03* other insulating materials consisting of or containing dangerous	Hazardous	High

SCOTTISH ENVIRONMENT PROTECTION AGENCY

EWC description	Waste Classification	Charging Classification
materials		
17 06 04 insulating materials other than those mentioned in 17 06 01 and 17 06 03	Non-Hazardous	Medium
17 06 05* construction materials containing asbestos	Hazardous	High
17 08 01* gypsum-based construction materials contaminated with dangerous substances	Hazardous	High
17 08 02 gypsum-based construction materials other than those mentioned in 17 08 01	Non-Hazardous	Medium
17 09 01* construction and demolition wastes containing mercury	Hazardous	High
17 09 02* construction and demolition wastes containing PCB (e.g. PCB-containing sealants, PCB-containing resin based floorings, PCB-containing sealed glazing units, PCB-containing capacitors)	Hazardous	High
17 09 03* other construction and demolition wastes (including mixed wastes) containing dangerous substances	Hazardous	High
17 09 04 mixed construction and demolition wastes other than those mentioned in 17 09 01, 17 09 02 and 17 09 03	Non-Hazardous	Medium
18 01 01 sharps (except 18 01 03)	Non-Hazardous	Medium
18 01 02 body parts and organs including blood bags and blood preserves (except 18 01 03)	Non-Hazardous	Medium
18 01 03* wastes whose collection and disposal is subject to special requirements in order to prevent infection (e.g. dressings, plaster casts, linen, disposable clothing, nappies)	Hazardous	High
18 01 04 wastes whose collection and disposal is not subject to special requirements in order to prevent infection	Non-Hazardous	Medium

SCOTTISH ENVIRONMENT PROTECTION AGENCY

EWC description	Waste Classification	Charging Classification
18 01 06* chemicals consisting of or containing dangerous substances	Hazardous	High
18 01 07 chemicals other than those mentioned in 18 01 06	Non-Hazardous	Medium
18 01 08* cytotoxic and cytostatic medicines	Hazardous	High
18 01 09 medicines other than those mentioned in 18 01 08	Non-Hazardous	Medium
18 01 10* amalgam waste from dental care	Hazardous	High
18 02 01 sharps (except 18 02 02)	Non-Hazardous	Medium
18 02 02* wastes whose collection and disposal is subject to special requirements in order to prevent infection	Hazardous	High
18 02 03 wastes whose collection and disposal is not subject to special requirements in order to prevent infection	Non-Hazardous	Medium
18 02 05* chemicals consisting of or containing dangerous substances	Hazardous	High
18 02 06 chemicals other than those mentioned in 18 02 05	Non-Hazardous	Medium
18 02 07* cytotoxic and cytostatic medicines	Hazardous	High
18 02 08 medicines other than those mentioned in 18 02 07	Non-Hazardous	Medium
19 01 02 ferrous materials removed from bottom ash	Non-Hazardous	Medium
19 01 05* filter cake from gas treatment	Hazardous	High
19 01 06* aqueous liquid wastes from gas treatment and other aqueous liquid wastes	Hazardous	High
19 01 07* solid wastes from gas treatment	Hazardous	High
19 01 10* spent activated carbon from flue-gas treatment	Hazardous	High

SCOTTISH ENVIRONMENT PROTECTION AGENCY

EWC description	Waste Classification	Charging Classification
19 01 11* bottom ash and slag containing dangerous substances	Hazardous	High
19 01 12 bottom ash and slag other than those mentioned in 19 01 11	Non-Hazardous	Medium
19 01 13* fly ash containing dangerous substances	Hazardous	High
19 01 14 fly ash other than those mentioned in 19 01 13	Non-Hazardous	Medium
19 01 15* boiler dust containing dangerous substances	Hazardous	High
19 01 16 boiler dust other than those mentioned in 19 01 15	Non-Hazardous	Medium
19 01 17* pyrolysis wastes containing dangerous substances	Hazardous	High
19 01 18 pyrolysis wastes other than those mentioned in 19 01 17	Non-Hazardous	Medium
19 01 19 sands from fluidised beds	Non-Hazardous	Medium
19 01 99 wastes not otherwise specified	Non-Hazardous	Medium
19 02 03 premixed wastes composed only of non-hazardous wastes	Non-Hazardous	Medium
19 02 04* premixed wastes composed of at least one hazardous waste	Hazardous	High
19 02 05* sludges from physico/chemical treatment containing substances	Hazardous	High
19 02 06 sludges from physico/chemical treatment other than those mentioned in 19 02 05	Non-Hazardous	Medium
19 02 07* oil and concentrates from separation	Hazardous	High
19 02 08* liquid combustible wastes containing dangerous substances	Hazardous	High
19 02 09* solid combustible wastes containing dangerous substances	Hazardous	High

SCOTTISH ENVIRONMENT PROTECTION AGENCY

EWC description	Waste Classification	Charging Classification
19 02 10 combustible wastes other than those mentioned in 19 02 08 and 19 02 09	Non-Hazardous	Medium
19 02 11* other wastes containing dangerous substances	Hazardous	High
19 02 99 wastes not otherwise mentioned	Non-Hazardous	Medium
19 03 04* wastes marked as hazardous, partly stabilised	Hazardous	High
19 03 05 stabilised wastes other than those mentioned in 19 03 04	Non-Hazardous	Medium
19 03 06* wastes marked as hazardous, solidified	Hazardous	High
19 03 07 solidified wastes other than those mentioned in 19 03 06	Non-Hazardous	Medium
19 04 01 vitrified waste	Non-Hazardous	Medium
19 04 02* fly ash and other flue-gas treatment wastes	Hazardous	High
19 04 03* non-vitrified solid phase	Hazardous	High
19 04 04 aqueous liquid wastes from vitrified waste tempering	Non-Hazardous	Medium
19 05 01 non-composted fraction of municipal and similar wastes	Non-Hazardous	Medium
19 05 02 non-composted fraction of animal and vegetable wastes	Non-Hazardous	Medium
19 05 03 off-specification compost	Non-Hazardous	Medium
19 05 99 wastes not otherwise specified	Non-Hazardous	Medium
19 06 03 liquor from anaerobic treatment of municipal waste	Non-Hazardous	Medium
19 06 04 digestate from anaerobic treatment of municipal waste	Non-Hazardous	Medium
19 06 05 liquor from anaerobic treatment of animal and vegetable waste	Non-Hazardous	Medium

SCOTTISH ENVIRONMENT PROTECTION AGENCY

EWC description	Waste Classification	Charging Classification
19 06 06 digestate from anaerobic treatment of animal and vegetable waste	Non-Hazardous	Medium
19 06 99 wastes not otherwise specified	Non-Hazardous	Medium
19 07 02* landfill leachate containing dangerous substances	Hazardous	High
19 07 03 landfill leachate other than those mentioned in 19 07 02	Non-Hazardous	Medium
19 08 01 screenings	Non-Hazardous	Medium
19 08 02 waste from desanding	Non-Hazardous	Medium
19 08 05 sludges from treatment of urban waste water	Non-Hazardous	Medium
19 08 06* saturated or spent ion exchange resins	Hazardous	High
19 08 07* solutions and sludges from regeneration of ion exchangers 19 08 08* membrane system waste containing heavy metals	Hazardous	High
19 08 08* membrane system waste containing heavy metals	Hazardous	High
19 08 09 grease and oil mixture from oil/water separation containing only edible oil and fats	Non-Hazardous	Medium
19 08 10* grease and oil mixture from oil/water separation other than those mentioned in 19 08 09	Hazardous	High
19 08 11* sludges containing dangerous substances from biological treatment of industrial water	Hazardous	High
19 08 12 sludges from biological treatment of industrial waste water other than those mentioned in 19 08 11	Non-Hazardous	Medium
19 08 13* sludges containing dangerous substances from other treatment of industrial waste water	Hazardous	High

SCOTTISH ENVIRONMENT PROTECTION AGENCY

EWC description	Waste Classification	Charging Classification
19 08 14 sludges from other treatment of industrial waste water other than those mentioned in 19 08 13	Non-Hazardous	Medium
19 08 99 wastes not otherwise specified	Non-Hazardous	Medium
19 09 01 solid wastes from primary filtration and screenings	Non-Hazardous	Medium
19 09 02 sludges from water clarification	Non-Hazardous	Medium
19 09 03 sludges from decarbonation	Non-Hazardous	Medium
19 09 04 spent activated carbon	Non-Hazardous	Medium
19 09 05 saturated or spent ion exchange resins	Non-Hazardous	Medium
19 09 06 solutions and sludges from regeneration of ion exchangers	Non-Hazardous	Medium
19 09 99 wastes not otherwise specified	Non-Hazardous	Medium
19 10 01 iron and steel waste	Non-Hazardous	Medium
19 10 02 non-ferrous waste	Non-Hazardous	Medium
19 10 03* fluff-light fraction and dust containing dangerous substances	Hazardous	High
19 10 04 fluff-light fraction and dust other than those mentioned on 19 10 03	Non-Hazardous	Medium
19 10 05* other fraction containing dangerous substances	Hazardous	High
19 10 06 other fraction other than those mentioned in 19 10 05	Non-Hazardous	Medium
19 11 01* spent filter clays	Hazardous	High
19 11 02* acid tars	Hazardous	High
19 11 03* aqueous liquid wastes	Hazardous	High
19 11 04* wastes from cleaning of fuels with bases	Hazardous	High

SCOTTISH ENVIRONMENT PROTECTION AGENCY

EWC description	Waste Classification	Charging Classification
19 11 05* sludges from on-site effluent treatment containing dangerous substances	Hazardous	High
19 11 06 sludges from on-site effluent treatment other than those mentioned in 19 11 05	Non-Hazardous	Medium
19 11 07* wastes from flue-gas cleaning	Hazardous	High
19 11 99 wastes not otherwise specified	Non-Hazardous	Medium
19 12 01 paper and cardboard	Non-Hazardous	Medium
19 12 02 ferrous metal	Non-Hazardous	Medium
19 12 03 non-ferrous metal	Non-Hazardous	Medium
19 12 04 plastic and rubber	Non-Hazardous	Medium
19 12 05 glass	Non-Hazardous	Medium
19 12 06* wood containing dangerous substances	Hazardous	High
19 12 07 wood other than that mentioned in 19 12 06	Non-Hazardous	Medium
19 12 08 textiles	Non-Hazardous	Medium
19 12 09 minerals (e.g. sand, stones)	Non-Hazardous	Medium
19 12 10 combustible waste (refuse derived fuel)	Non-Hazardous	Medium
19 12 11* other wastes (including mixtures of materials) from mechanical treatment of waste containing dangerous substances	Hazardous	High
19 12 12 other wastes (including mixtures of materials) from mechanical treatment of waste other than those mentioned in 19 12 11	Non-Hazardous	Medium
19 13 01* solid wastes from soil remediation containing dangerous	Hazardous	High

SCOTTISH ENVIRONMENT PROTECTION AGENCY

EWC description	Waste Classification	Charging Classification
substances		
19 13 02 solid wastes from soil remediation other than those mentioned in 19 13 01	Non-Hazardous	Medium
19 13 03* sludges from soil remediation containing dangerous substances	Hazardous	High
19 13 04 sludges from soil remediation other than those mentioned in 19 13 03	Non-Hazardous	Medium
19 13 05* sludges from groundwater remediation containing dangerous substances	Hazardous	High
19 13 06 sludges from groundwater remediation other than those mentioned on 19 13 05	Non-Hazardous	Medium
19 13 07* aqueous liquid wastes and aqueous concentrates from groundwater remediation containing dangerous substances	Hazardous	High
19 13 08 aqueous liquid wastes and aqueous concentrates from groundwater remediation other than those mentioned in 19 13 07	Non-Hazardous	Medium
20 01 01 paper and cardboard	Non-Hazardous	Medium
20 01 02 glass	Inert	Low
20 01 08 biodegradable kitchen and canteen waste	Non-Hazardous	Medium
20 01 10 clothes	Non-Hazardous	Medium
20 01 11 textiles	Non-Hazardous	Medium
20 01 13* solvents	Hazardous	High
20 01 14* acids	Hazardous	High
20 01 15* alkalines	Hazardous	High
20 01 17* photochemicals	Hazardous	High

SCOTTISH ENVIRONMENT PROTECTION AGENCY

EWC description	Waste Classification	Charging Classification
20 01 19* pesticides	Hazardous	High
20 01 21* fluorescent tubes and other mercury-containing waste	Hazardous	High
20 01 23* discarded equipment containing chloroflourocarbons	Hazardous	High
20 01 25 edible oil and fat	Non-Hazardous	Medium
20 01 26* oil and fat other than those mentioned in 20 01 25	Hazardous	High
20 01 27* paint, inks, adhesives and resins containing dangerous substances	Hazardous	High
20 01 28 paint, inks, adhesives and resins other than those mentioned in 20 01 27	Non-Hazardous	Medium
20 01 29* detergents containing dangerous substances	Hazardous	High
20 01 30 detergents other than those mentioned in 20 01 29	Non-Hazardous	Medium
20 01 31* cytotoxic and cytostatic medicines	Hazardous	High
20 01 32 medicines other than those mentioned in 20 01 31	Non-Hazardous	Medium
20 01 33* batteries and accumulators included in 16 06 01, 16 06 02 or 16 06 03 and unsorted batteries and accumulators containing these batteries	Hazardous	High
20 01 34 batteries and accumulators other than those mentioned in 20 01 33	Non-Hazardous	Medium
20 01 35* discarded electrical and electronic equipment other than those mentioned in 20 01 21 and 20 01 23 containing hazardous components	Hazardous	High
20 01 36 discarded electrical and electronic equipment other than those mentioned in 20 01 21, 20 01 23 and 20 01 35	Non-Hazardous	Medium
20 01 37* wood containing dangerous	Hazardous	High

SCOTTISH ENVIRONMENT PROTECTION AGENCY

EWC description	Waste Classification	Charging Classification
substances		
20 01 38 wood other than that mentioned on 20 01 37	Non-Hazardous	Medium
20 01 39 plastics	Non-Hazardous	Medium
20 01 40 metals	Non-Hazardous	Medium
20 01 41 wastes from chimney sweeping	Non-Hazardous	Medium
20 01 99 other fractions not otherwise specified	Non-Hazardous	Medium
20 02 01 biodegradable waste	Non-Hazardous	Medium
20 02 02 soil and stones	Inert	Low
20 02 03 other non-biodegradable wastes	Non-Hazardous	Medium
20 03 01 mixed municipal waste	Non-Hazardous	Medium
20 03 02 waste from markets	Non-Hazardous	Medium
20 03 03 street-cleaning residues	Non-Hazardous	Medium
20 03 04 septic tank sludge	Non-Hazardous	Medium
20 03 06 waste from sewage cleaning	Non-Hazardous	Medium
20 03 07 bulky waste	Non-Hazardous	Medium
20 03 99 municipal wastes not otherwise specified	Non-Hazardous	Medium